

Instruction Manual



Pool Relax Chlorine
Pool Relax Bromine
Pool Relax Oxygen

Contents

1	Introduction	5	10.1	View in the home display	37
2	Identification of safety information	6	10.2	Temperature configuration	37
2.1	Safety information	6	11	Automatic dosing system O2 (Bayrosoft®)	38
2.2	Miscellaneous markings.....	6	11.1	View in the home display	38
3	General safety information	6	11.2	O2 (Bayrosoft®) menu.....	39
3.1	New Functions	8	11.2.1	Configuration and Settings O2 (Bayrosoft®).....	39
3.2	User qualification	8	11.3	Basic principles.....	39
4	Default access codes	9	11.4	Main dosing	40
5	Installation of Pool Relax	9	11.5	Intermediate dosing	40
5.1	General Information	9	11.5.1	Trend of effective Bayrosoft® concentration in water	41
5.2	Selecting the Installation Location	9	11.6	Additional dosings.....	41
5.3	Mounting Pool Relax on the Wall.....	10	12	Alarm monitoring	42
5.4	Electrical Connection	11	12.1	Overview.....	42
5.4.1	Double Dosing Pump Lock	11	12.2	Flow alarm	43
5.4.2	Earthing the Measurement Cell	11	12.2.1	Automatic quitting of the flow alarm (default variant)	43
5.5	Installation Plans.....	12	12.2.2	Manual quitting of the flow alarm.....	43
5.5.1	Installation of Pool Relax with pH-Minus	12	12.2.3	Monitoring of the measuring water	43
5.5.2	Installation of Pool Relax with pH-Plus	14	12.3	Power-on delay.....	43
5.6	Putting into Operation	15	12.4	Alarm signalling	43
5.6.1	Pool Relax Chlorine	15	12.5	Blocking of dosing by alarms	44
5.6.2	Pool Relax Oxygen	15	12.6	Alarm settings	44
5.6.3	Pool Relax Bromine	17	12.6.1	Acoustic alarms	44
5.6.4	Maintenance of Pool Relax.....	17	12.6.2	Flow alarm settings (in Service menu only).....	44
5.7	Maintenance Plan	17	12.6.3	Level alarm settings (in Service menu only).....	44
5.8	Dosing Pump Hoses	18	13	Service messages	45
5.9	Electrode Information.....	19	13.1	Overview	45
5.9.1	Electrode Wear	19	13.2	Signalling of due service messages	45
5.9.2	Electrode Care	19	13.3	Re-planning of service messages	45
5.9.3	Calibrating Electrodes.....	19	14	Event log	46
5.10	Decommissioning / Winter Storage of the System	19	14.1	Overview	46
6	Operating Pool Relax	20	15	Manual dosing	47
6.1	Overview of Features.....	20	15.1	Overview	47
6.1.1	Display and Operation	20	15.2	"Manual Dosage" menu	47
6.1.2	Measuring and control	20	15.3	Blocking by alarms.....	48
6.1.3	Safety functions	20	15.4	Special case of shock chlorination	48
6.2	Operation	21	15.5	Special case of pump test (pH / mV / O2)	48
6.2.1	Touchscreen	21	16	Add-on Modules	49
6.2.2	Direct selection buttons.....	21	16.1	Universal switch outputs	49
6.2.3	Entering data.....	22	16.1.1	Overview	49
6.3	Commissioning menu	23	16.1.2	Programming the switch outputs	49
7	Software	25	16.1.3	Manual mode	49
7.1	Menu structure	25	16.1.4	Other Operating Modes	50
7.2	Schematic diagram of menu structure	25	16.1.5	Blocking by flow	50
7.3	Login	30	16.1.6	Level Alarm IN1 / IN2	50
7.4	Direct Menu Links in Home Menu	30	16.1.7	Display in the Home Menu	50
7.4.1	Login with direct links	30	16.1.8	Application examples.....	51
8	pH Control	31	16.2	Mounting of an additional cable feed-through	52
8.1	View in the home display	31	17	Service	53
8.2	Configuration of pH Control	31	17.1	Connections on the Controller Housing.....	53
8.2.1	Setpoint, alarm limits, p-range	31	17.2	Connections in the Controller Housing.....	54
8.2.2	pH electrode calibration	32	17.3	Opening the housing	55
9	mV (redox) control	34	17.4	Controller Board.....	56
9.1	View in the home display	34	17.4.1	Changing the Buffer Battery	56
9.2	mV (redox potential) configuration	34	17.4.2	Changing the Fuse	56
9.2.1	Setpoint, limits, p-range	34	18	Changing the care method	56
9.2.2	Redox electrode calibration	36	19	Software update	57
10	Temperature measurement	37	19.1	Preparation of the USB memory stick	57

Contents

19.2	Opening the housing and mounting a USB memory stick ..	57
19.3	Bootloader Update	57
19.4	PR3 Software Update (Application software)	57
19.5	Check of the Installed Software Version	57
20	Troubleshooting and fault elimination.....	58
21	Technical Data.....	60
22	EC Declaration of Conformity	61

1 Introduction

Congratulations on the purchase of your Pool Relax measuring, controlling and dosing system. You have decided for a device that greatly simplifies the care of your swimming pool with its high quality design and operating reliability. Regardless of which treatment method you have decided to use, your new Pool Relax will manage the water quality in your pool.

Pool Relax is available as:

Pool Relax Chlorine

For measuring and controlling pH and redox values, dosing of pH-Minus or pH-Plus (adjustable) and Chloriliquide.

Pool Relax Bromine

For measuring and controlling pH and redox values, dosing of pH-Minus or pH-Plus (adjustable). Bromine, a water disinfection agent, is dissolved in a feeder and added as needed via a dosing valve.

Pool Relax Oxygen

For measuring and controlling pH and redox values, dosing of pH-Minus or pH-Plus (adjustable), and time-controlled and temperature-compensated dosing of Bayrosoft®.

Pool Relax provides up to four switching outputs which can be used very flexibly and allow for many different system configurations.

If you would like to have access to your Pool Relax system from anywhere, we recommend the use of the Web module (from 2018). This module can be plugged into your Pool Relax as an option. It connects to the BAYROL Web portal (www.bayrol-poolaccess.com) via your local home network.

To obtain crystal clear water, **Flockmatic®** can be used as an option with all three treatment variants. By continuously adding the flocculant, the system even removes particles from the swimming pool water that would otherwise simply pass through the sand filter of your system.

Please read these instructions carefully to familiarize yourself with the system and how to operate it.

It is essential to follow the safety instructions in the following chapter and throughout this manual!

BAYROL strongly recommends the installation of this system by experienced and trained specialist dealers only.

If you have any questions, please contact your dealer or the BAYROL Service Centre.

2 Identification of safety information

2.1 Safety information



HAZARD!

Hazard identification

Hazard description

Description of (potential) consequences

Measure to be undertaken in order to avoid this hazard.



HAZARD DUE TO VOLTAGE!

Hazard identification

Hazard description

Description of (potential) consequences

Measure to be undertaken in order to avoid this hazard.



Required user qualification:

USER QUALIFICATION (description)

Explanatory text...

2.2 Miscellaneous markings



IMPORTANT NOTICE!

Brief description

Informational text...



INFO

Brief description

Information...



INFO

The corresponding section applies only for the Pool Relax version(s) indicated

3 General safety information

This user manual has basic information that should be observed during assembly, start-up, operation, and maintenance. Therefore, this user manual absolutely must be read by installers and operators prior to assembly and start/up, and must be accessible to every user of this device. Additionally, all further safety information in this document absolutely must be observed.

Read and follow all instructions.

In order to minimise the danger of injury, do not allow children to use this product.

Hazards from non-compliance with safety information

Non-compliance with safety information can result in hazards to persons, the environment, and the equipment.

Non-compliance with safety information will result in a forfeit of any potential right to damage compensation.



HAZARD!

Corrosive / flammable dosing fluids

The dosing fluids used are corrosive and / or flammable.

Potential consequence:

Severe or possibly fatal injury, serious damage to property.

- Always observe the relevant health and safety regulations when installing and using the device.
- Never let the ends of the dosing hoses connected to the dosing pumps unconnected to avoid contact with the corrosive or flammable fluids.
- The system must be installed, commissioned and operated by qualified expert personnel only.

**HAZARD!****Dangerous system settings**

Changing the system settings (default values) can be dangerous under certain circumstances.

Potential consequence:

Severe or possibly fatal injury, serious damage to property.

- Settings must be changed by trained technicians only.
- The operator assumes liability if settings are used improperly or modified.

**HAZARD!****Unexpected start**

Pool Relax starts operation as soon as there is voltage on the incoming power line. It is possible that dosing pumps start or that add-on functions are turned on or switched.

Potential consequence:

Severe or possibly fatal injury, serious damage to property.

- Be sure that Pool Relax is secured against unauthorised access.
- Do not supply Pool Relax with power until all preparations for a safe start and safe operation have been completed.

**HAZARD!****Potential overdosing of maintenance products**

Despite Pool Relax comprehensive safety functions, it is possible that a sensor failure and other errors could lead to an overdosing of maintenance products.

Potential consequence:

Severe or possibly fatal injury, serious damage to property.

- Design your installation such that uncontrolled dosage is not possible in the event of a sensor failure or other errors, and/or such that uncontrolled dosage is recognised and halted before damage is incurred.

**HAZARD!****Gaseous chlorine produced from dosing in standing water if dosing outputs are not locked via the filter pump**

If the flow switch is stuck or experiences another error, there is a risk of dosing into standing water. Poisonous chlorine gas can be yielded when sodium hypochlorite and pH minus come together.

Potential consequence:

Severe or possibly fatal injury, serious damage to property.

- Only run power to input L_D [35] / N_D [36] for the dosing outputs if circulation is running (dosing outputs must be locked via the filter pump).
- Connect power input L_D [35] / N_D [36] to the timer that controls the filter pump, or use the corresponding outlet on the filter pump.
- If Pool Relax is controlling the filter pump directly, then locking automatically occurs internally.
- Please also refer to the Section 230V~ Power Supply.

**HAZARD!****Use of non-BAYROL products**

The use of other products such as hydrochloric acid to control the pH value can quickly result in serious damage.

Potential consequence:

Severe injury, serious damage to property.

- The system must be operated with BAYROL products only.
- BAYROL does not provide a guarantee or accept liability for problems caused by using other manufacturers' products.

**HAZARD!****Damage of the touch screen**

Any contact to the touch screen with objects such as pens, knives or nails may cause scratches or other damages of the surface.

Potential consequence:**Damage or failure of the touch screen.**

- Do not touch the screen of the device with anything else but the finger.
- Use a soft cloth and a mild cleaner to clean the touch screen and remove
- Any damage caused by misapplication will result in loss of warranty!



HAZARD!

Compliance with safety class

If the housing or individual cable glands have not been properly closed after working on the Pool Relax such that a reliable seal has been secured, then it will be possible for moisture to penetrate into the device.

Potential consequence:

Damage or destruction to Pool Relax, malfunctions.

- Be sure the unit is safely sealed again after performing any kind of work.

3.1 New Functions

The internal software (firmware) of the Pool Relax is continued to be developed. New software versions may provide new, extended or improved functions, which are not described in this version of the user manual.



HAZARD!

Use of new functions

Because of the continued development, a Pool Relax may contain functions, which are not or not completely described in this version of the user manual. The use of such new or extended functions without a profound and secure understanding by the operator may result in malfunctions and severe problems.

Potential consequence:

Severe or possibly fatal injury, serious damage to property.

- Make sure to get a profound and secure understanding of a function and relevant boundary conditions, before you start to use it.
- Check for an updated version of the user manual or additional documentation available for the relevant functions.
- Make use of the integrated help function of the Pool Relax to get detailed information on functions and their parameter settings.
- In case it should not be possible to get a profound and secure understanding of a function based on the available documentation, do not use this function.

3.2 User qualification



HAZARD!

Insufficient personnel qualification

Hazards in the event of insufficiently qualified personnel

Potential consequence:

Severe or possibly fatal injury, serious damage to property.

- The system operator must ensure compliance with the required qualification level.
- Any and all work may only be performed by correspondingly qualified personnel.
- Access to the system must be prevented for insufficiently qualified persons, e.g. via access codes and passwords.

Designation	Definition
Instructed person	An instructed person is someone who has been informed of and, as necessary, trained in the assigned tasks and the potentially associated hazards, and has been notified of the required safety equipment and measures.
Trained user	A trained user is someone who meets the requirements for an instructed person and has additionally received training specific to the system.
Trained specialist	A trained specialist is someone who meets the requirements of a trained user and additionally can assess assigned work tasks and recognise potential hazards based on training, knowledge, and experience as well as on familiarity with relevant norms and provisions. Multiple years of work experience in the respective field may also be assessed as specialised training.
Electrical specialist	An electrical specialist is someone who is capable of performing work on electrical systems and independently recognising and avoiding potential hazards based on specialist training, knowledge, and experience as well as familiarity with the relevant norms and provisions. An electrical specialist must meet the provisions in the applicable legal stipulations regarding accident prevention.
IT specialist	An IT specialist (IT = information technology) is someone who is capable of performing work on computer systems, networks, and network components and independently recognising and avoiding potential hazards based on professional training, knowledge, and experience as well as on familiarity with the relevant norms and provisions.

**IMPORTANT NOTICE**

The system operator must ensure compliance with the relevant accident prevention conditions, with all legal regulations, and with the generally recognised technical safety principles!

4 Default access codes

**HAZARD!****Unauthorised access possible from using known access codes**

Access codes facilitate access to critical areas on the system. Unauthorised access can lead to dangerous configurations.

Potential consequence:**Severe or possibly fatal injury, serious damage to property.**

- Configure individualised access codes. Under no circumstances should the preconfigured standard access codes be used.
- Keep access codes strictly confidential.

The following table indicates the standard default access codes.

Menu	Default access code (should be changed in the menu Controller Settings > Code Numbers!)
Main Menu (Customer)	1234
Main Menu (Service)	5678

5 Installation of Pool Relax

5.1 General Information

Perform all installation work carefully and comply with the applicable safety regulations. During installation, disconnect the measurement, control and dosing device and all other electrical loads such as the electrical heating or the circulating pump from the mains.

In addition, comply with the applicable regulations regarding the installation of electrical devices.

General notes on installation:

- Ensure that the hoses are laid without kinking and that chafing cannot occur.
- Avoid laying the hoses over sharp edges.
- Carefully connect all hoses and check that the connections are firmly attached.
- Avoid unnecessarily long hose lengths.
- Do not guide the hoses directly over warm pipes or systems.
- Check that the float in the measurement chamber can float freely.
- Adjust the water flow through the cell so that the float just barely lies against the upper end in its guide bore.
- If you are using a Flockmatic® pump for dosing Quickflock Automatic Plus, please connect it to a connection controlled by the circulating pump (circulation OFF – flocculation OFF; circulation ON – flocculation ON)

5.2 Selecting the Installation Location

To mount Pool Relax, select a dry, frost-protected, sheltered and level location on a vertical wall. Ensure that the area is readily accessible and well ventilated. There should be no energized electrical cables, contactors, electric motors, etc. in its vicinity. The installation location should be as close as possible to where the measuring water is extracted and returned.

The supply voltage for the controller and the vacuum pumps should not exceed 240V/50 Hz. The allowable operating temperature range is from 0 to 50 °C, and the allowable humidity level equals 0-90 %.

5.3 Mounting Pool Relax on the Wall



1. The base plate with the mounted measurement cell can be used as a template by holding it up against the mounting location and marking the drill holes on the wall.
 2. After the base plate is securely mounted on the wall, the controller housing is attached to the tongue and groove joint provided for this purpose.
 3. The housing is attached using a slotted screw, (see picture).
- Connect the supplied pH pressure line on one side with the pressure side (right connector) of the left-hand vacuum pump. Connect the other side with the upper injection piece of the measurement cell. Ensure that the connection is tight and securely fastened.
 - Connect the supplied pressure line for Chloriliquide or Bayrosoft® on one side with the pressure side (right hand hose connector) of the right-hand vacuum pump. Connect the other side with the upper injection piece of the measurement cell. Ensure that the connection is tight and securely fastened.

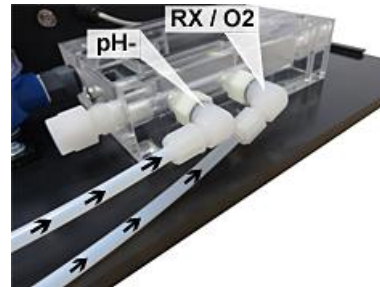

- Connect the flow switch and the temperature sensor (Pool Relax Oxygen only). Ensure that the connectors are inserted in the sockets provided for this purpose (see the "Stickers on Controller Housing" and "Connections on Controller Housing" chapters).

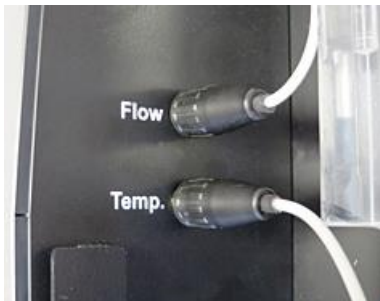

5.4 Electrical Connection

The system has been designed and constructed according to the applicable regulations. It was carefully inspected before leaving the factory and left the factory in a perfectly safe condition.

The equipment can only be operated safely if all of the instructions contained in this manual are followed. The equipment should be installed by a licensed electrician.

The supply voltage for the device may not exceed 240 V / 50 Hz. The allowable operating temperature range is from 0 to 50 °C, and the allowable humidity level equals 0-90 %.

Ensure that all plug-in connections are protected against water, as is standard practice for electrical connections.

5.4.1 Double Dosing Pump Lock

Pool Relax is equipped with a double pump lock that offers a very high level of safety.

The flow switch in the measurement cell ensures that the dosing pumps can only be switched on if a sufficient amount of water is flowing through the measurement cell.

In addition, the dosing pumps are supplied with the line voltage through a separate power supply. The power supply must be switched in such a manner that the dosing pumps are only supplied with current when the circulating pump is running.

In this way, dangerous dosing is prevented even in situations in which there is no flow, i.e. the system is doubly safeguarded.

For connections, please see the "Connections on Controller Housing" chapter.

5.4.2 Earthing the Measurement Cell

The Pool Relax measurement cell is equipped with an earth screw that is used for diverting any potentials on the pool water.



Note

The earthing provided chamber **MUST** be installed. Make sure that the earthing is functioning properly. Always ensure that fault current is not flowing into the water of the swimming pool. Professional measurement is recommended.

5.5 Installation Plans

5.5.1 Installation of Pool Relax with pH-Minus

5.5.1.1 Pool Relax Chlorine installation

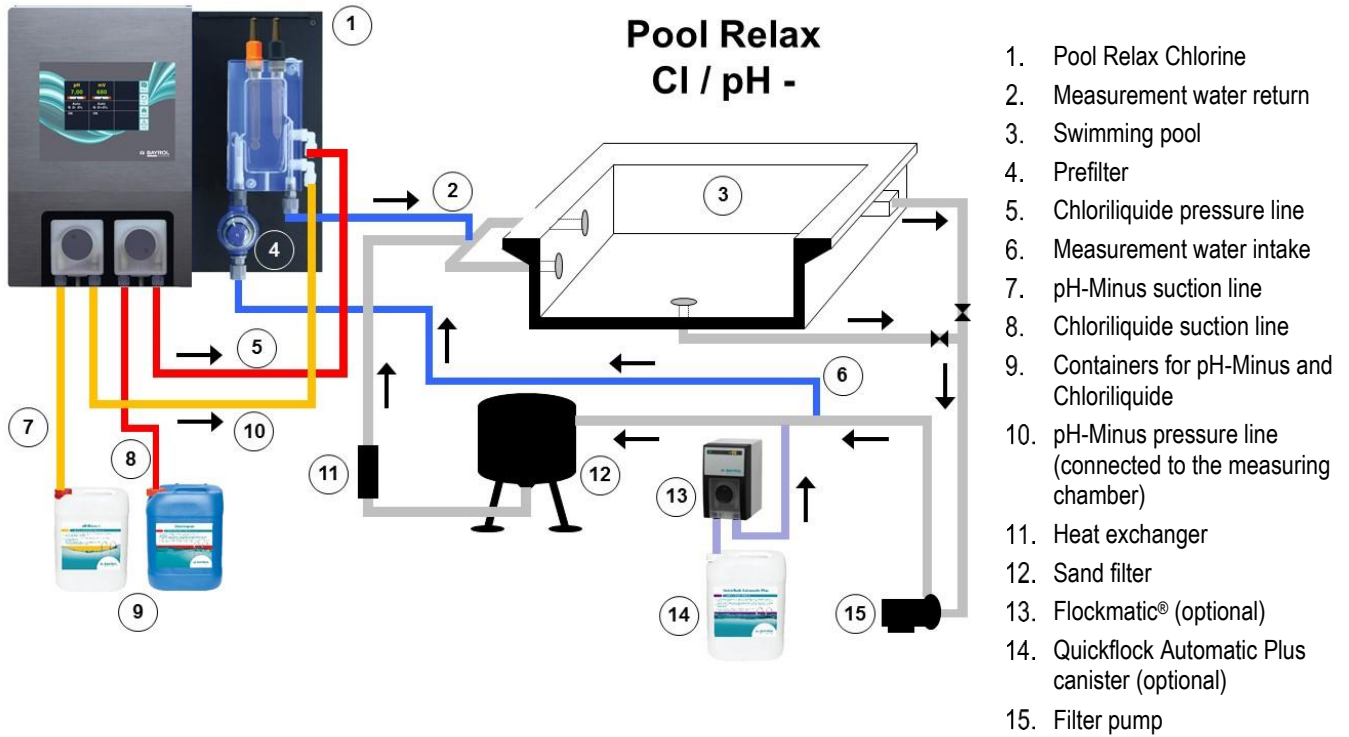

5.5.1.2 Pool Relax Oxygen installation

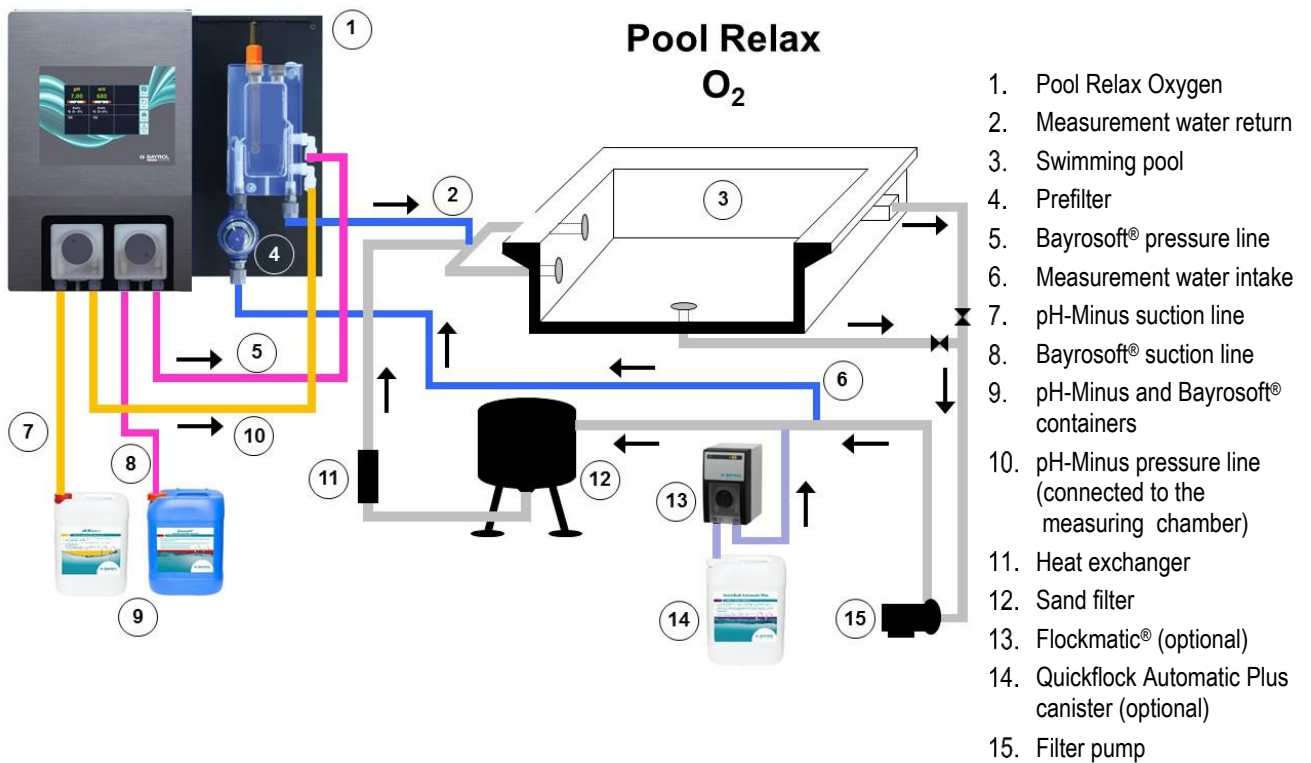

5.5.1.3 Pool Relax Bromine installation

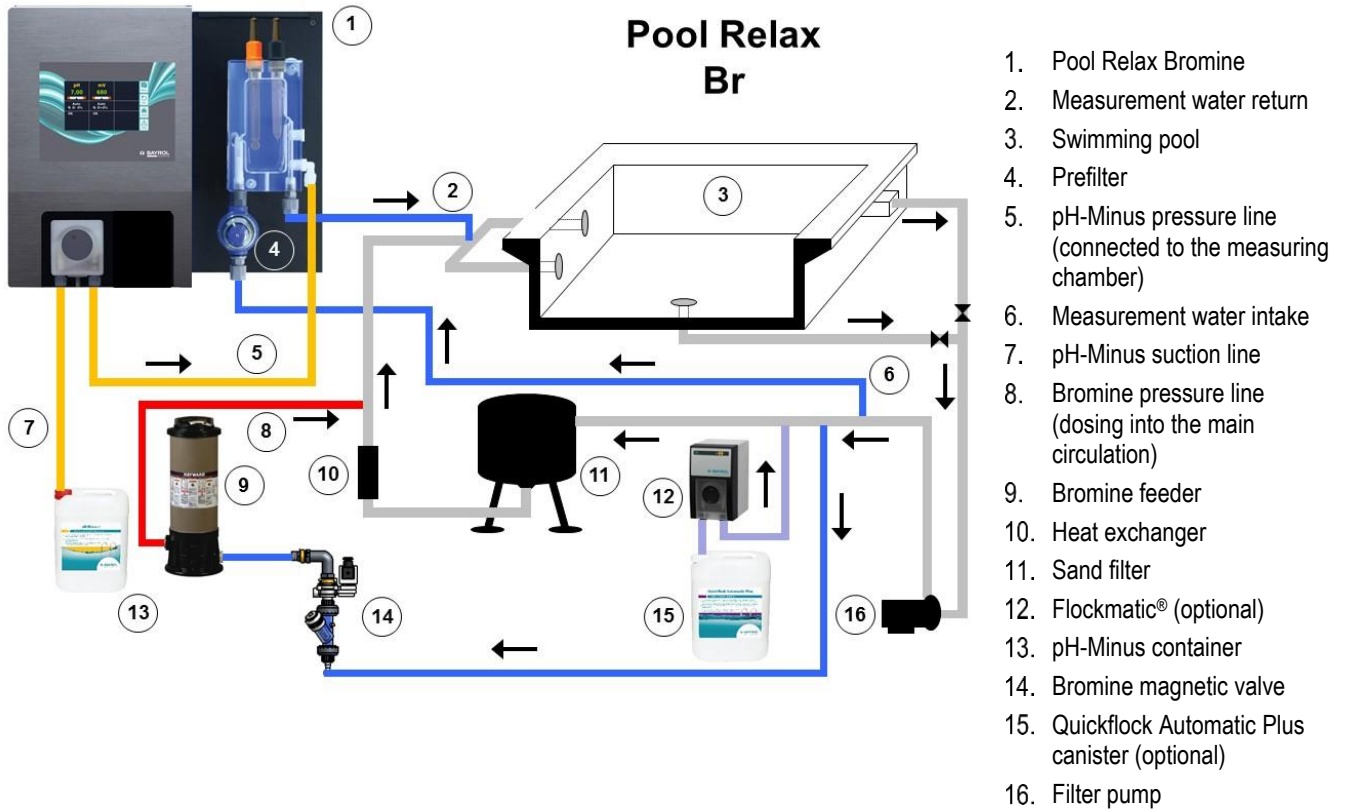

5.5.2 Installation of Pool Relax with pH-Plus



Important notice

Should pH-Plus be utilised for increasing the pH value instead of pH-Minus for reducing the pH value, the pH-Plus may not be feed into the measurement cell, **it must** be fed directly into the circulating line.

You will require the following accessories (available at your BAYROL dealer):

- 100 509 PE hose (length depending on the installation situation)
 - 171 207 Injection piece 0.5 bar (1 piece)
 - 112 283 PVDF Plug screw (1 piece)
 - 112 174 Saddle clamp 50mm ½"
 - or
 - 112 148 Saddle clamp 63mm 1" + 112 151 Adapter 1"-1/2"
 - or
 - 112 149 Saddle clamp 75mm 1" + 112 151 Adapter 1"-1/2"
- (dependent on the pipe diameter of the circulation system in each case)

Installation:

- If possible, fit the saddle clamp for the injection piece for pH-Plus directly in front of the return of the water to the pool, but after all built-in parts (e.g. heat exchanger) into the circulation system.
- Screw in the injection piece 171 207 into the threads of the saddle clamp. Ensure a secure sealing.
- Remove the upper white PVDF elbow on the measurement chamber of the Pool Relax and instead screw in the PVDF plug screw 112 283 in the measurement chamber. Ensure a secure sealing.
- Connect the PE hose 100 509 to the pressure side of the pH dosing pump of the Pool Relax. Run this hose in the most direct path as possible to the injection piece. Do not run the hose over sharp edges and do not run it directly past heat-conducting pipes. Ensure a secure and tight connection at pH dosing pump and injection piece.
- Connect the suction line, which is located on the suction lance with the suction input (left connection) of the dosing pump. Ensure that all connections are tight and securely fastened.

Installation example for Pool Relax Chlorine.

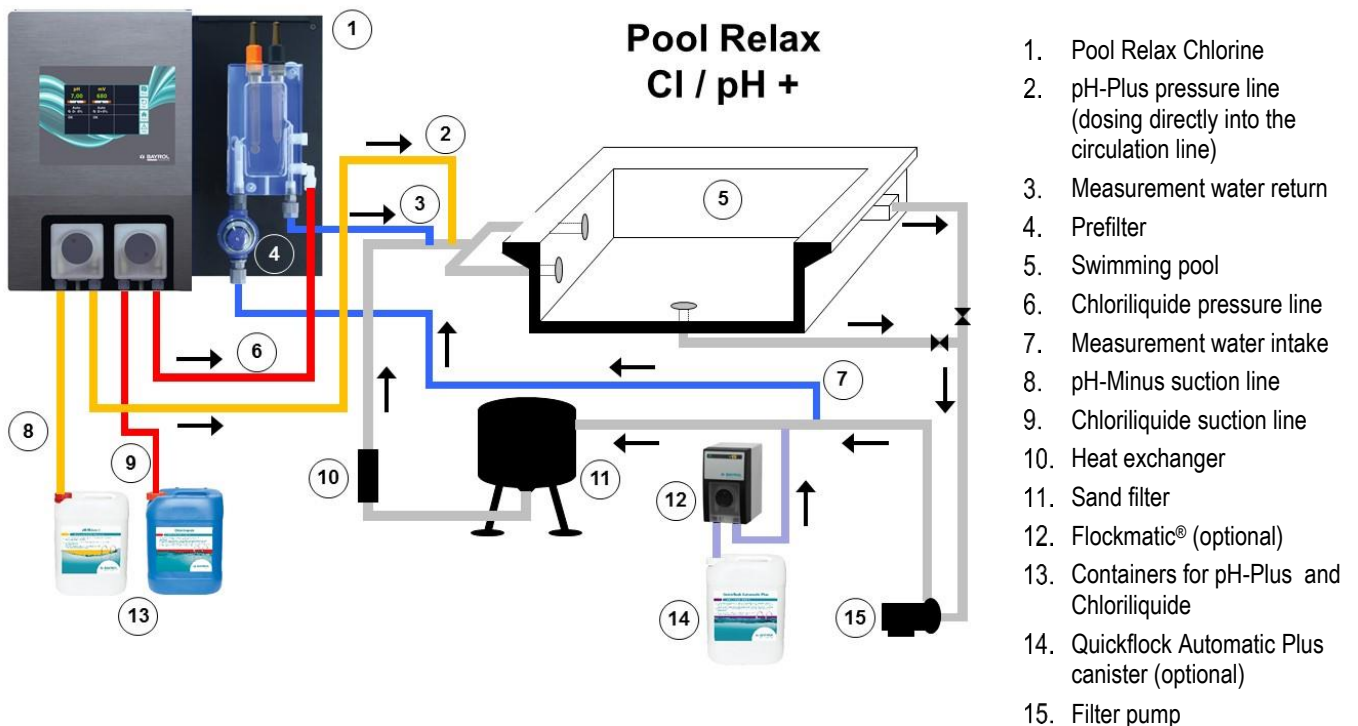

5.6 Putting into Operation

Before putting the system into operation, all previously described steps must be performed and the conditions specified there must be met!

In addition, the containers with the water care agents must be connected to the system.

- To do so, connect the hose of the dosing lances with the suction side (left connector) of the respective dosing pump. Ensure that the hose lengths are short and that the screw connections on the pump and suction lance are firmly attached.
- Connect the hose for backflow with the white hose clip at the dosing pump. Insert the opposite side of the hose in the suction lance where suction hose and cable are situated. Take care for firm connection!



ATTENTION

Please make sure under all circumstances that the liquids flowing back through both backflow hoses never get in contact with each other!

Contact between Chlorilquide and pH-Minus may result in the production of poisonous chlorine gas!

- Connect the BNC connectors of the suction lances with the respective socket on the controller (see also the "Connection on Controller Housing" chapter).



ATTENTION

Use BAYROL water care products only! The use of water treatment products of other sources than BAYROL results in loss of warranty.

5.6.1 Pool Relax Chlorine

- Bring the pH value of the pool water to 7.2. You can manually dose the pH to do so (see "pH Measuring and Control Module"). If the pH value differs widely from 7.2, you can use pH-Minus/pH-Plus in a granular form (it is important that you follow the dosing instructions on the product package). It is important that you check the pH value with the supplied pool tester.
- After adjusting the pH value, bring the chlorine value of the swimming pool water to the desired level of free chlorine (recommendation: 0.6 mg/l). You can manually dose the Cl to do so (see "Redox Measuring and Control Module"). In large pools, you can also use Chlorifix (follow the dosing instructions on the product packaging). It is important that you check the chlorine value with the supplied pool tester.
- When you adjust the pH and chlorine value of the pool water, you can simultaneously calibrate the pH and redox electrodes with the buffer solution provided. Apply the 1-point calibration method for both electrodes.
- The redox value that results when the chlorine value of the pool water is adjusted (recommendation: 0.6 mg/l) can be used as the redox setpoint. A precondition is that the pH value must already be close to the setpoint (+/- 0.1) and the redox electrode must be calibrated with the redox buffer. Under certain conditions, the measurement of the redox potential may take longer than expected. Please wait until the displayed value of mV has fully stabilized.
- As soon as the pH and redox values in the pool water are close to the setpoints, you can set the control of the two control modules to Auto.
- We recommend that you monitor the control behaviour over a period of time and adjust it to the conditions prevailing in the pool, if necessary. In particular, this applies when the current values in the pool still vary widely from the setpoints.

5.6.2 Pool Relax Oxygen

To ensure good water quality when treating water with Bayrosoft®, carefully adhere to the following requirements.

A) Technical requirements

- Correct installation and operation of the pool's hydraulic equipment, water supply (including overflow tank) and filtering system
- The filter must operate for at least 10 hours/day
- Backwash at least once a week
- Sufficiently high backwash speed of 60 m/h and backwash time of at least 3 minutes
- Walls and floor of the pool must be cleaned regularly using a suction device – pool vacuum cleaner
- Filter sand must be checked regularly and replaced as necessary

B) Measures required in addition to dosing with Bayrosoft®

- Before putting the system into operation, administer a shock chlorination using 25 g of Chlorifix per cubic metre of water. The chlorine should act for at least 3 days.
- A lined swimming pool with a new liner must be treated with chlorine for at least 14 days during which the chlorine level must be kept constant at over 3 mg/l.
- After this period, start the Bayrosoft® treatment immediately and do not wait for the chlorine level to break down.
- Regular flocculation with Superflock Plus or the Flockmatic® dosing device (Quickflock Automatic Plus) is highly recommended.
- Occasionally check that Bayrosoft® is present in the water. If possible, do this on the day preceding the next dosing (there should still be at least 10 mg/l of Bayrosoft® in the pool).
- To check this, simply dip a Bayrosoft® Quicktest - test strip into the water. A blue discolouration indicates that Bayrosoft® is present.

C) Tips and tricks regarding inadequate water quality (Bayrosoft®)

Generally speaking, inadequate water quality is caused by a lack of Bayrosoft® in the swimming pool's water over a long period of time. Organic substances can build up in the water, resulting in cloudiness or causing the swimming pool walls to become slippery. When this first occurs, check to see whether there is any Bayrosoft® in the water. Dip a Bayrosoft® test strip in the water shortly before the next dosing takes place. The test strip must at least turn light blue (corresponds to approx. 10 mg/l). If no trace of Bayrosoft® can be detected, increase the dose amount so that Bayrosoft® is always present in the water.

D) How can the water quality be corrected?

- If the problem is just that the water is cloudy but the pool walls are not slippery, a double manual dosage and the addition of a Superflock Plus flocculation cartridge will be sufficient. The water quality will be correct by the next day.
- If the water is cloudy and the pool walls are slippery, this indicates severe organic contamination and it will be necessary to administer a single shock chlorination in order to return the water to the required quality. Note: Bayrosoft® and chlorine neutralise each other, thereby rendering each other ineffective. Therefore, it must be ensured that no Bayrosoft® remains in the water before applying chlorine. Otherwise the chlorine will be ineffective. Use the Bayrosoft® Quicktest -test strips. An effective shock chlorination is only possible after there is no blue discolouration, indicating that there is no more Bayrosoft® in the water.
- Recommended dose amount for an effective chlorine shock:
1 tablet of Chloriklar® per cubic metre or 25 grams of Chlorifix per cubic metre.

Important: When administering a shock chlorination, it is essential to clean the pool by mechanical means in addition. Slippery deposits form a so-called "bio-film", which is not completely eliminated even with high concentrations of chlorine. As soon as the slippery deposit is destroyed by mechanical cleaning, the chlorine can act and fully break down the organic contaminants. Resume Bayrosoft® water treatment at least 24 hours but no later than 48 hours after the chlorine shock is administered. You do not need to wait for the chlorine levels to break down.

Procedure for Putting into Operation

- Bring the pH value of the pool water to 7.2. You can manually dose the pH to do so (see "pH measuring and control module"). If the pH value differs widely from 7.2, you can use pH-Minus/pH-Plus in a granular form (it is important that you follow the dosing instructions on the product package). Check the pH value with the supplied Pooltester / Bayrosoft® Quicktest - test strips.
- Perform the shock chlorination specified under B).
- Determine the basic dose according to the formula

$$\frac{\text{Pool volume [m}^3\text{]} \cdot 0,5}{10} = \text{Bayrosoft® basic dose [litres]}$$

and enter this value into the device as the basic dose.

- When you adjust the pH value or perform a shock chlorination, you can simultaneously calibrate the pH electrode with the supplied buffer solution. Apply the 1-point calibration method.
- As soon as the pH value is close to the setpoints, you can set the control of the pH value and the O₂ automatic dosing system to Auto. At high water temperatures, also activate the temperature compensation (see "Configuration O₂" and "Functional Description O₂").
- We recommend that you monitor the control behaviour over a period of time and adjust it to the conditions prevailing in the pool, if necessary.
- In any case, it is necessary that you check the Bayrosoft® content in the pool water using the supplied Bayrosoft® test strips. Shortly **after** the main dosing, the measured value should equal 35-50 mg/l (dark blue colour) and shortly **before** the next main dosing the value should equal at least 10 mg/l (light blue colour).

5.6.3 Pool Relax Bromine

- Bring the pH value of the pool water to 7.2. You can manually dose the pH to do so (see "pH measuring and control module"). If the pH value differs widely from 7.2, you can use pH-Minus/pH-Plus in a granular form (it is important that you follow the dosing instructions on the product package). It is important that you check the pH value with the supplied pool tester.
- First, bring the bromine value of the swimming pool water to the desired value. (Recommendation: 2-4 mg/l). ATTENTION: Depending on the pool size and water temperature, this bromine value may not reach its final level until after several days. To ensure a sufficient degree of water disinfection from the beginning, we recommend an initial disinfection with chlorine, e.g. with Chlorifix. It is important that you check the bromine value with the supplied pool tester.
- When you adjust the pH and bromine value of the pool water, you can simultaneously calibrate the pH and redox electrodes with the supplied buffer solution. Apply the 1-point calibration method for both electrodes.
- The redox value that results when the bromine value of the pool water is adjusted (recommendation: 2-4 mg/l) can be used as the redox setpoint. A precondition is that the pH value must already be close to the setpoint (+/- 0.1) and the redox electrode must be calibrated with the redox buffer. Under certain conditions, the measurement of the redox potential may take longer than expected. Please wait until the displayed value of mV has fully stabilized.
- As soon as the pH and redox values in the pool water are close to the setpoints, you can set the control of the two control modules to Auto.
- We recommend that you monitor the control behaviour over a period of time and adjust it to the conditions prevailing in the pool, if necessary. In particular, this applies when the current values in the pool still vary widely from the setpoints.

5.6.4 Maintenance of Pool Relax



ATTENTION

Disconnect all power connections before beginning maintenance work!

5.7 Maintenance Plan

Monthly maintenance:

- Visually inspect all dosing lines and hoses for leakages
- Check the filter sieve and clean it if necessary
- Check the water values with the supplied test kit and readjust the settings if necessary

Quarterly maintenance:

- Visually inspect all dosing lines and hoses for leakages
- Check the filter sieve and clean it if necessary
- Check and if needed clean the injection valves
- Check the water values with the supplied test kit and readjust the settings if necessary
- Calibrate the pH and redox electrodes using the supplied buffer solutions

Annual maintenance:

- Visually inspect all dosing lines and hoses for leakages
- Check the filter sieve and clean it if necessary
- Check the water values with the supplied test kit and readjust the settings if necessary
- Replace and calibrate the pH and redox electrodes using the supplied buffer solutions
- Replace the hoses of the dosing pumps
- Replacement of the membrane of the injection valves

5.8 Dosing Pump Hoses

The hoses of the dosing pumps must be replaced annually or earlier if worn. Use original replacement hoses only. They can be obtained from your swimming pool dealer.

Hose change

The dosing pump's hose is replaced without removing the rotor.

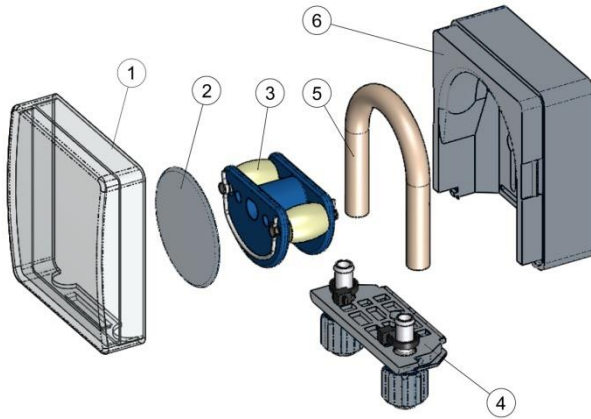

- Remove the empty suction and pressure hoses from the hose fastener. To do so, loosen the blue clamp screws.
- Remove transparent cover 1 from the pump.
- Remove transparent cover 2 from the rotor.
- Turn rotor 3 such that the flat side faces left and is vertical.
- Pull hose fastener 4 from its bracket and lift on the left side.
- Turn rotor 3 clockwise and remove the cable while lifting on it until it is completely free.
- To install, perform in the opposite order.

Either the hose can be replaced alone, or the hose and hose fastener can be replaced jointly. It is recommended to replace hose and hose fastener jointly.

Art. no.	Designation	Application
127313	Replacement hose set 1.5 l/h (hose with hose fastener)	Chlorine and pH for pool sizes up to ca. 100 m ³
127356	Replacement hose set 3.0 l/h (hose with hose fastener)	Chlorine and pH for pool sizes of approx. 100 m ³ to ca. 200 m ³ and for dosing Bayrosoft®.
127303	Pump hose 1.5 l/h (hose without hose fastener)	Chlorine and pH for pool sizes up to ca. 100 m ³
127353	Pump hose 3,0 l/h (hose without hose fastener)	Chlorine and pH for pool sizes of approx. 100 m ³ to ca. 200 m ³ and for dosing Bayrosoft®.



NOTE!

If only the hose is being replaced, then the following absolutely must be observed during installation

- The hose sits securely in the grommets.
- Under no circumstances may the hose be twisted when installed.
- Ensure the hose clip sits securely.

5.9 Electrode Information

The electrodes must be replaced annually or earlier if worn. Use original replacement electrodes only. They can be obtained from your swimming pool dealer.

5.9.1 Electrode Wear

The following conditions, among others, indicate that the electrodes are worn:

- During calibration, the electrode takes unusually long to reach the value of the buffer solution.
- The electrode offset during calibration is too large.
- The KCL solution in the electrode shaft is used up or discoloured.



ATTENTION

Electrodes wear very rapidly if there is an electric potential in the pool water!

5.9.2 Electrode Care

- The pH-sensitive membrane glass must be handled with care and protected against damage.
- The inner reference solution in the glass electrode must cover the inner surface of the membrane glass. Any air bubbles are removed by gently shaking the electrode vertically (like shaking a medical thermometer). Contamination deposited on the surface of the membrane glass must be removed by carefully wiping it with a moist paper towel. Alternatively, you can use the supplied electrode cleaning solution.

5.9.3 Calibrating Electrodes

Notes on calibrating electrodes can be found in the corresponding chapters and in the calibration examples.

5.10 Decommissioning / Winter Storage of the System

If the system is put out of operation for lengthy periods, e.g. for winter storage, certain precautionary measures need to be taken. In particular, it is very important that the entire system is protected against freezing temperatures and humidity.

Dosing System

- Rinse the pump with fresh, lukewarm water for about 30 minutes. To do so, place the suction lance into a pail filled with tap water and start a manual dosing.
- Ensure that the system is fully disconnected from the power grid.
- Release the hose set to prevent permanent deformation.

Measuring System

- Store the electrodes in an upright position in the containers in a location where temperatures will not drop below zero. The three molar KCL solution in the containers protects the electrodes from drying out.
- Close both electrode drill holes of the measurement cell with the supplied cover screws.
- Let the water drain from the measurement chamber and measurement lines.

6 Operating Pool Relax

6.1 Overview of Features

6.1.1 Display and Operation

- High resolution wide format 4,3" colour touch screen (480 x 272 pixels)
- Simple operation via touch screen
- Clear menu structure
- Many different menu languages included
- Screen with automatic switch-off to save energy (adjustable)
- Context sensitive online help via "Help" hotkey

6.1.2 Measuring and control

- Proportional control for all control modules
- All important control parameters can be programmed individually for each control module (setpoint, max. dosing time, proportional range, dead zone, basic dosing (mV) cycle time, min. on / off time)
- Continuous display of current dosing rate
- Conversion of all measurements by high resolution 10-bit analogue/digital converters
- 1 or 2 point calibration for pH
- 1point calibration for redox (mV) and temperature

6.1.3 Safety functions

- Comprehensive monitoring and alarm functions
 - Upper and lower alarms, flow alarm, level alarms, dosing time alarms, battery alarm, power-on delay
- Automatic blocking of dosing during critical alarm conditions, during power-on delay
- Alarm notification through:
 - display
 - acoustic alarm signal
 - alarm relay
- Continuous monitoring of the correct program sequence and automatic reset in the event of an error (watchdog function)
- Double dosing pump lock
 Pool Relax is equipped with a double pump lock that offers a very high level of safety. The flow switch in the measurement cell ensures that the dosing pumps can only be switched on if a sufficient amount of water is flowing through the measurement cell.
 In addition, the dosing pumps are supplied with the line voltage through a separate power supply. The power supply must be switched in such a manner that the dosing pumps are only supplied with current when the circulating pump is running. In this way, dangerous dosing into stationary water is prevented even if one of the two fuses should blow due to external causes.
- Alternating switching on of the dosing pumps
 As soon as a dosing pump starts running, the other pump is blocked. This prevents the agents for raising or lowering the pH from being dosed together with the water disinfection agent (Chloriliquide or Bayrosoft®).
 Because perfect water disinfection is only possible at a pH value of 7.2, dosing of the agents for raising and lowering the pH takes precedence over dosing of the water disinfection agent.



HAZARD!

Emission of chlorine gas in case of contact between Chloriliquide and pH-Minus

Poisonous chlorine gas is emitted if Chloriliquide and pH-Minus get in contact.

Potential consequence:

Severe or possibly fatal injury, serious damage to property.

- Make sure that Chloriliquide and pH-Minus never get in contact.
- Make sure that Chloriliquide and pH-Minus are never dosed into non-circulated water.
- The power supply for the dosing pumps must absolutely be connected in a way, which guarantees that the dosing pumps are only powered when the circulation pump is running.

6.2 Operation

6.2.1 Touchscreen

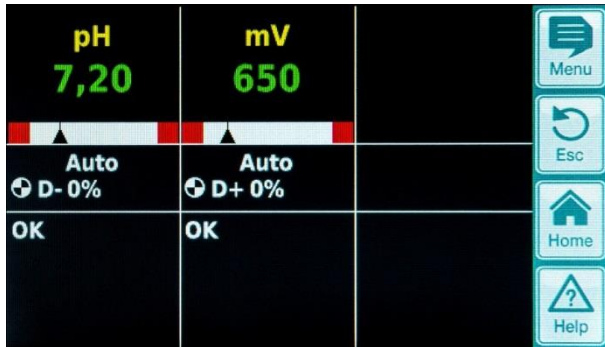

The touch screen is a high-resolution colour screen that responds to finger touch. Please note that light pressure is fully adequate to achieve the desired reaction.

Although the screen is very robust and long-lived, please ensure that it is not scratched and that it does not get into contact with corrosive fluids (e.g. Chlorilquide (Sodium Hypochlorite), pH-Plus, pH-Minus, Bayrosoft® etc.).

To clean the screen, use a mild cleaner on a soft cloth. Always wipe it with a damp cloth after cleaning.

Do not touch the screen of the device with anything else but the finger. Any contact with other objects such as pens, knives or nails may cause scratches or other damages of the surface.

Any damage caused by misapplication will result in loss of warranty!

6.2.2 Direct selection buttons



Menu button

To change from the normal display to the selection of further menus.

These are:

- Main Menu (Customer)
- Main Menu (Service)
- Alarms
- Measurement Graph
- Service Messages
- Mode of Operation (Auto / Off) / Switched Outputs



Esc button

To return to the preceding menu.

Note: Changes are not saved.



Home button

To change back to the normal display from any menu page.



Help button



To display context-sensitive help on the current menu.

6.2.3 Entering data

Entries or changes are very easy to make and always involve the same steps.

In general: Any value or term surrounded by a white frame or inverted (black text in a white button or box) can be changed. If you wish to make a change, lightly touch the area within the frame on the screen with your finger. The display responds by opening the menu page with the desired content.

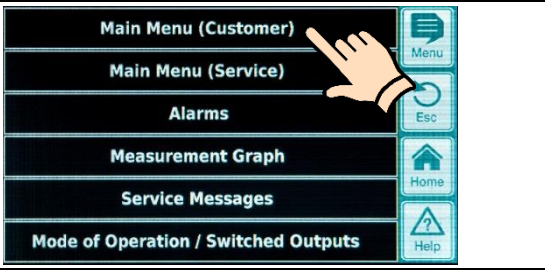
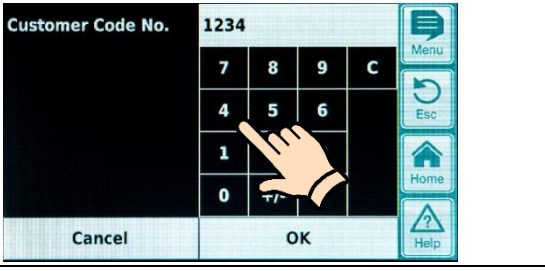
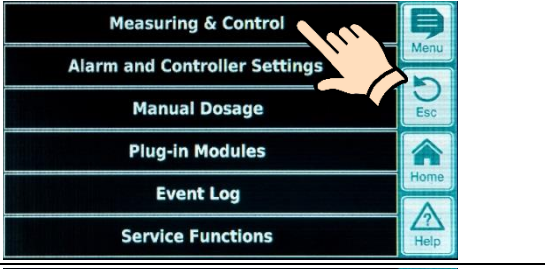
The method used to make an entry is illustrated in the following example, which shows how to change the pH setpoint:

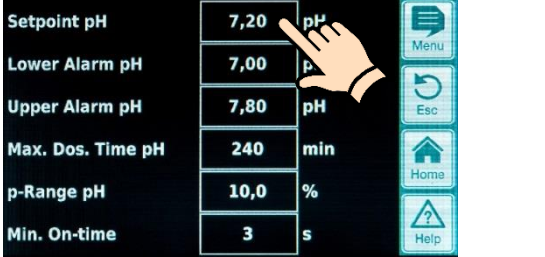
	<p>Open the menu</p>
	<p>Select the Main Menu (Customer)</p>
	<p>Enter the Customer Code No. – OK (Default setting: 1234)</p>
	<p>Select the "Measuring & Control" menu</p>
	<p>Select the "pH" menu</p>
	<p>Select the pH setpoint by placing your finger within the frame next to the term</p>

	<p>Enter the desired pH setpoint (e.g. pH 7.3) using the numerical keypad that appeared and confirm with "OK"</p>
	<p>The new pH value is accepted (in this case, e.g. 7.3 pH) You can now close the page step-by-step by pressing Esc (e.g. to make further changes in other menus) or return to the normal display directly using the Home button</p>

6.3 Commissioning menu

Pool Relax has a menu for use in commissioning the system. All parameters that are relevant to successfully installing the equipment can be set in this menu. Despite the fact that this menu greatly facilitates commissioning, the procedure may only be performed by qualified technicians. All parameters to be set must be checked carefully. The conditions in and around the pool must be evaluated professionally and considered when programming the device.

The menu for commissioning appears when the device is first switched on. It can also be opened at any time using the Service Functions menu item in the main menu (service).

The following parameters can be set:

Action	Input
Step 1: Language	
Select the menu language	
Step 2: Setting default parameters	
The default value set to be used can be selected here.	Select the location where the device is used. If unsure, check and change, if necessary, all default values to ensure they are correct for the respective installation. For added security, activation of the default values must be confirmed.
Step 3: Pool parameters	
Set up the pool and system parameters	Volume of connected swimming pool Configuration of the employed pump.
Pool Relax Oxygen:	
Step 4: Calibration	
Calibrate (balance) the pH measurements	1-point calibration for pH. Please proceed as described in chapter 7.3 or in the help text in the device.
Step 5: Control parameters pH	
Set up the main parameters for pH control	When the pool is refilled, it may be useful to extend the upper and lower thresholds of the pH value and to adjust the p-range since the pH value may fluctuate somewhat in the run-in phase. ATTENTION: If you adjust the parameters, ensure that the values are returned to their standard settings after the pool water has stabilised.
Step 6: Manual dosage O2 (Bayrosoft®)	
Start manual dosage	The dose amount (for 1 l Bayrosoft®/10 m ³ water volume) is calculated by entering the pool volume, after which manual dosing can be started here. To increase the dose amount for initial dosing and to thereby increase disinfection efficacy, a dose amount that is double or three times the usual amount can be selected.

Step 7: Dosing parameters O2	
Set up the main parameters for the Bayrosoft® automatic dosing system	The dose amount is calculated by entering the pool volume and is displayed here for checking (0.5 l Bayrosoft® / 10 m ³ water). It can be changed if necessary. The dosing day should be one day prior to the day with the greatest anticipated water contamination (e.g. high rate of pool use). The temperature compensation ensures that more Bayrosoft® is added at higher water temperatures (greater product attrition). It should be set to Normal or greater.
Pool Relax Chlorine/Bromine	
Step 4: Calibration	
Calibrate (balance) the pH and redox measurements	<ul style="list-style-type: none"> • 1-point calibration for pH. Please proceed as described in Chapter 4.2.2 or in the help text in the device. • 1-point calibration for mV. Please proceed as described in Chapter 4.3.2 or in the help text in the device.
Step 5: Control parameters pH	
Set up the main parameters for pH control	When the pool is refilled, it may be useful to extend the upper and lower thresholds of the pH value and to adjust the p-range since the pH value may fluctuate somewhat in the run-in phase. ATTENTION: If you adjust the parameters, ensure that the values are returned to their standard settings after the pool water has stabilised.
Step 6: pH adjustment	
Option to automatically/manually adjust the pH value of the pool water	The set pH setpoint and the current pH value of the pool water are displayed. NOTE: The pH value of the pool water must be adjusted to pH 7.2 to ensure that the redox values can be adjusted correctly. <ol style="list-style-type: none"> 1. Set the pH operating mode to Auto if Pool Relax is to make the adjustment automatically. The time the procedure takes depends on the pool size and the water quality. 2. Set the operating mode to Manual if you want to adjust the pH value by manually adding agents that raise or lower the pH value.
Step 7: Manual dosage mV (Cl)	
Adjust the correct chlorine content and determine the mV value	The appropriate mV setpoint depends on the pool. It must be determined for the particular pool water. Proceed as follows: <ol style="list-style-type: none"> 1. Adjust the pH value to pH 7.2 (see previous step) 2. Using manual dosage (or by adding chlorine manually), adjust the chlorine content to approx. 0.5-0.6 mg/l (value recommended in Germany, can also be higher) in the pool water. The dose amount of Chloriliquide is determined by Pool Relax on the basis of the pool volume entered. This quantity can be overwritten manually. 3. The redox value in mV that is now displayed (measure chlorine content manually until the desired value is set) is the value that must be entered as the setpoint in the next step.
Step 8: Control parameters mV (redox)	
Set up the most important parameters for the redox control	Set the mV value to the setpoint reached at a chlorine content of 0.5-0.6 mg/l chlorine. Adjust the lower and upper alarm thresholds accordingly. Check the p-range.

From each individual menu page, you can leaf forward and backward through the pages.

7 Software

7.1 Menu structure

All menus and parameters in the software can be accessed on two levels.

- The "Main menu (customer)" access level (code no. "1234") displays all menu items and parameters relevant for an unexperienced user.
- The "Main menu (service)" access level (code no. "5678") displays all menu items and parameters contained in the software.
- The "Entry menu", which appears immediately after the menu button is touched, is not protected by a code number and offers rapid and simple access to some important Pool Relax functions:
- **Alarms**
Displays all current alarms.
- **Measurement Graph**
Graphical display of the measurement readings
- **Service messages**
Displays all current service messages.
- **Mode of Operation / Switched Outputs**
The dosing outputs can be activated or deactivated in this menu [Auto / Off]



AS A GENERAL RULE, THE PARAMETERS IN THIS MENU MAY ONLY BE CHANGED BY QUALIFIED AND TRAINED TECHNICIANS!

7.2 Schematic diagram of menu structure

The following pages show the menu tree of the Pool Relax.

Important menus in the main menu tree:

1. **Home view**
Shows all important measuring and status information at a glance.
Pressing the "Home" hotkey always returns to the Home view directly.
2. **Alarms**
Displays active alarms (if there are any)
3. **Mode of Operation / Switched Outputs**
The dosing outputs can be activated or deactivated in this menu [Auto / Off]
4. **Help page**
Is activated by the "Help" hotkey and shows context-sensitive help information
5. **Measuring & Control**
Setup and calibration of measuring, control and dosing for pH and free chlorine
6. **Manual dosage**
Start the dosing pumps manually to add chlorine or pH regulator
7. **Event Log**
Shows the history of alarms and other important events

Besides the main menu tree, the following pages also show the menu trees for the following functions:

- **Measuring & Control**
- **Alarm & Controller Settings**
- **Manual Dosage**
- **Plug-in Modules**
- **Service Functions**

After first power-on

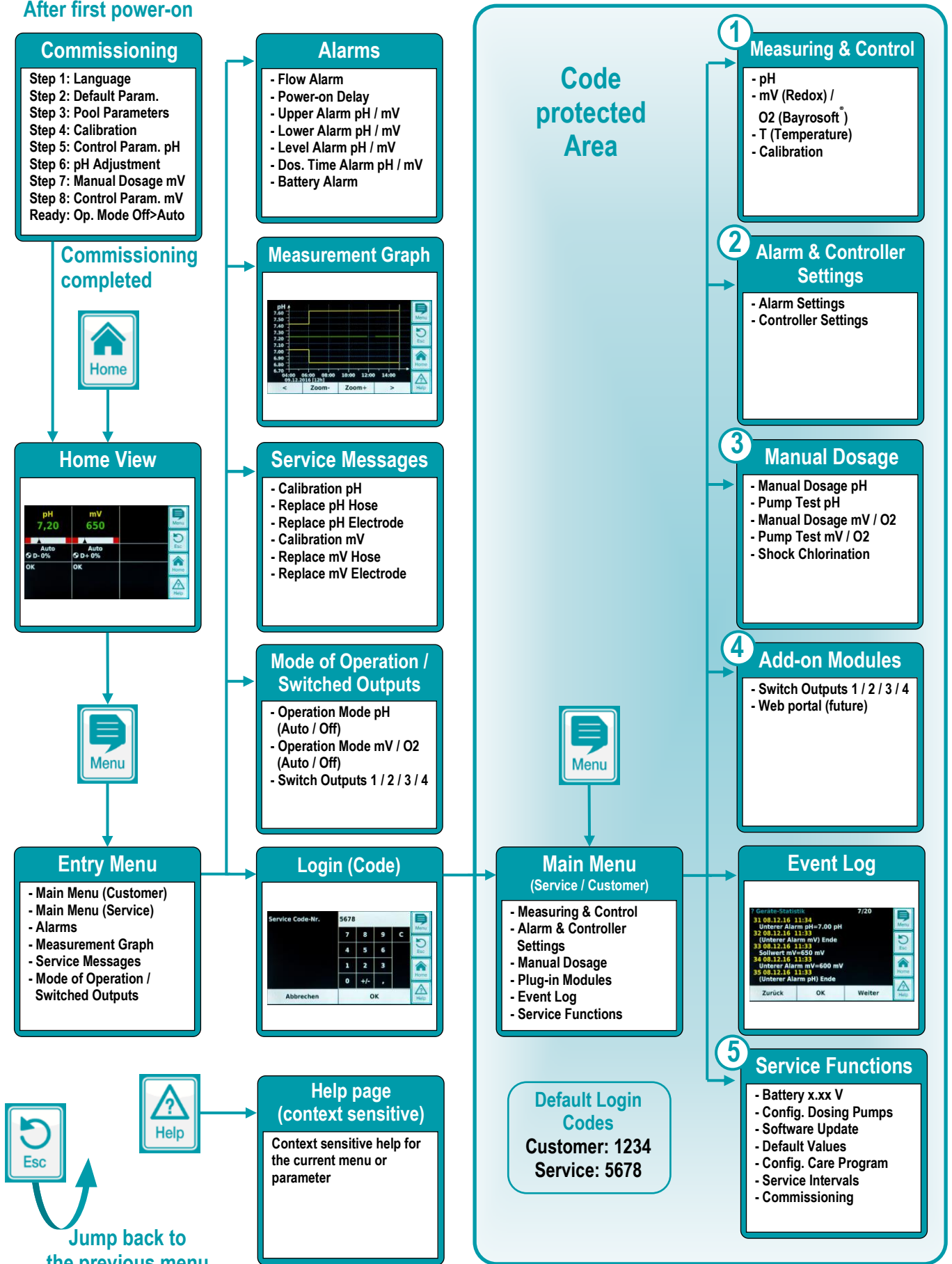

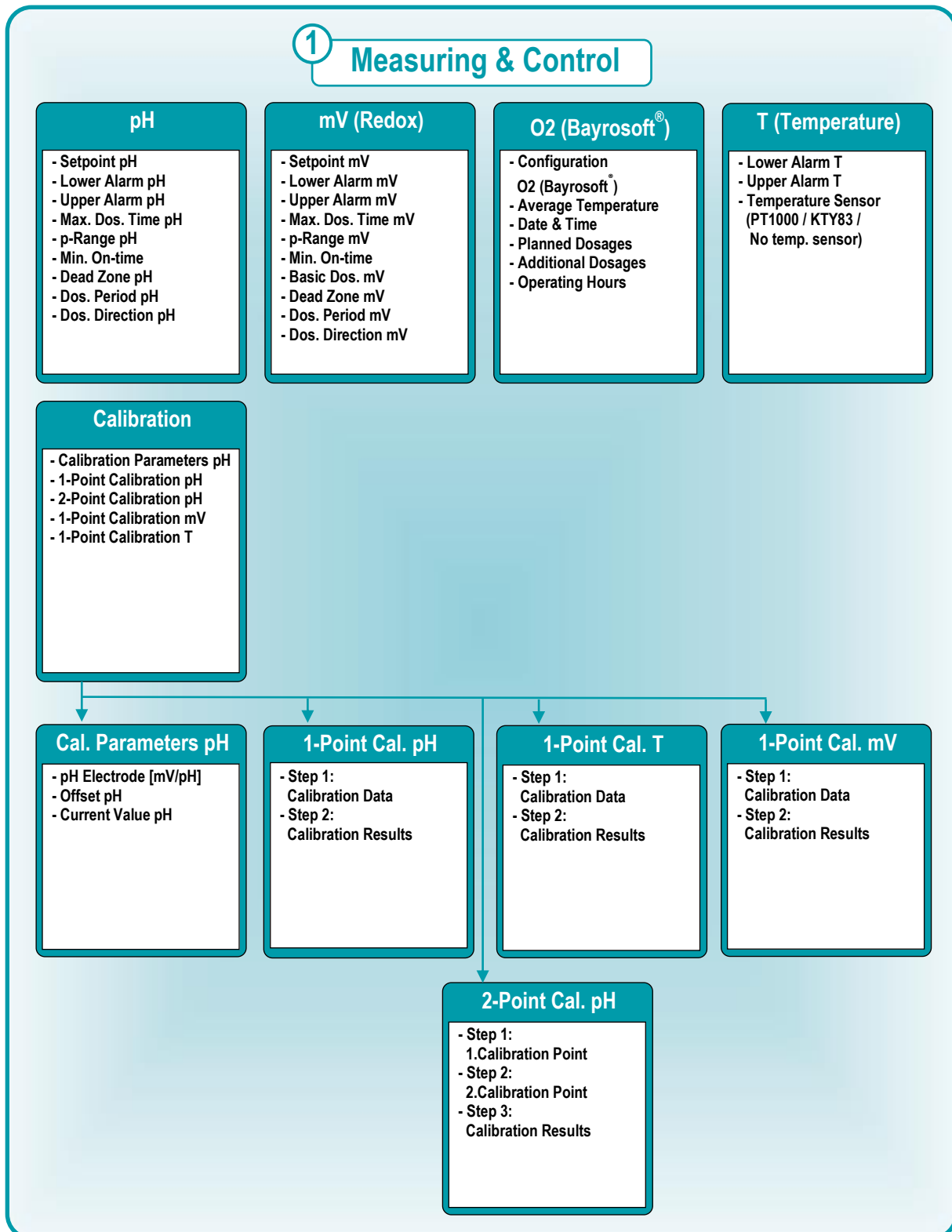

2 Alarm & Controller Settings

Alarm Settings

- Flow Alarm Settings
- Level Alarm Settings
- Sound Alarm Settings

Controller Settings

- Language
- Date & Time
- Code Numbers
- Powerdown Mode Settings
- Touch Panel Calibration
- Brightness Adjustment

Flow Alarm Settings

- Power-on Delay [min]
- Delay Flow Alarm [s]
- Quit Flow Alarm [Auto / Manual]
- Eventlog [Yes / No]

Level Alarm Settings

- Level Alarm pH [Inactive / Active]
- Level Alarm mV / O2 [Inactive / Active]
- Dos. At Level Al. [no / YES]

Sound Alarm Settings

- Sound Alarm Flow [Active / Inactive]
- Sound Alarm Level [Active / Inactive]
- Sound Alarm Others [Active / Inactive]
- Sound Alarm Messages [Active / Inactive]

3 Manual Dosage

Manual Dosage pH

- Current Value pH
- Hose Config. pH [l/h]
- Manual Dos. Amount [l]
- Manual Dos. Time pH [min]
- Start / Stop
- Manual Dosage

Manual Dosage mV

- Current Value mV
- Hose Config. mV [l/h]
- Manual Dos. Amount [l]
- Manual Dos. Time mV [min]
- Start / Stop
- Manual Dosage

Manual Dosage O2

- Hose Config. O2 [l/h]
- Manual Dos. Amount [l]
- Manual Dos. Time O2 [min]
- Start / Stop
- Manual Dosage

Shock Chlorination

- Hose Config. Cl [l/h]
- Pool Volume [m³]
- Dosing Amount [l]
- Start / Stop
- shock chlorination

Pump Test pH

- Pump Test pH [min]
- Start / Stop
- Pump Test

Pump Test mV

- Pump Test mV [min]
- Start / Stop
- Pump Test

Pump Test O2

- Pump Test O2 [min]
- Start / Stop
- Pump Test

4 Plug-in Modules

Switch Output 1 / 2 / 3 / 4

- Name
- Mode of Operation
[On / Off / Time controlled / Heating / Dosage pH- / Dosage pH+ / Dos. mV/O2]
- Blocked by Flow [Yes / No]
- Level Alarm IN1/2 [Off / On]
- Show in Home [Yes / No]

Web portal

Future function
Please refer to separate user manual for the Web portal

5 Service Functions

Config. Dosing Pumps

Hose Config. pH [l/h]
Hose Config. mV / O2 [l/h]

Software Update

- PR3 Software Update
- BOOTLOADER Update

Default Values

- Default Reset
- Commissioning [Off / On]

Config. Care Program

- Current Type
[Pool Relax O2 / Cl / Br]
- New Type
[Pool Relax O2 / Cl / Br]
- Code No.

- Activate new Type

Service Intervals

- Service Messages
- Re-plan Service Messages
- Cal. Interval pH / mV / T
[months]
- Replace pH / mV Electr.
[months]
- Replace pH / mV / O2 Hose
[months]

Commissioning

- Step 1: Language
- Step 2: Default Param.
- Step 3: Pool Parameters
- Step 4: Calibration
- Step 5: Control Param. pH
- Step 6: pH Adjustment
- Step 7: Manual Dosage mV
- Step 8: Control Param. mV
- Ready: Op. Mode Off>Auto

Display options

- Out 1/2 in Home
[No / Yes]

7.3 Login

If you want to enter the Main Menu (Customer) or the Main Menu (Service), you must login with the Customer Code or Service Code, respectively. The default codes are indicated in the menu tree above.

If you have entered the correct code once, it remains valid for five minutes and you do not need to enter it again.

In the standard configuration, you must also login to the menus for the four switching functions (OUT1/2/3/4), which are located in the “Mode of Operation / Switched Outputs” menu.

If you want to access these menus without login, you can change the following setting:

Main Menu (Service) → Alarm and Controller Settings → Controller Settings → Code Numbers → Switch Output Menu

Setting	Description
Service Code	You must login to the configuration menus for the switching functions with the Service Code.
Customer Code	You must login to the configuration menus for the switching functions with the Customer Code.
No Code	You can access all configuration menus for the switching functions without login.

7.4 Direct Menu Links in Home Menu

By touching in different areas of the Home Menu you can directly jump to several important menus:

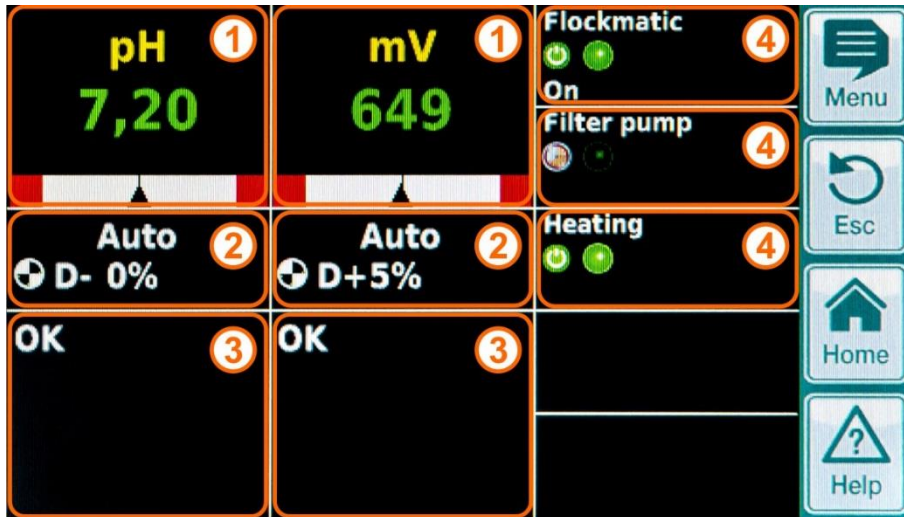

Pos.	Direct Link
1	Direct links to the configuration menus of the individual measuring and control functions (pH, mV (redox) or O2 (Bayrosoft®), temperature T)
2	Direct links to the “Operating Mode / Switched Outputs”, where the different functions and devices can quickly be switched on or off.
3	Direct link to the alarm menu
4	Direct links to the configuration menus of the individual switching functions which are displayed in the Home Menu

7.4.1 Login with direct links

In the standard configuration, you must login by entering the Service Code, if you are using a direct link from the home menu. This guarantees maximum security.

If you want to use the direct links without login, you can change the following setting:

Main Menu (Service) → Alarm and Controller Settings → Controller Settings → Code Numbers → Home Menu

Setting	Description
Service Code	You must login with the Service Code if you use a direct link in the Home Menu.
Customer Code	You must login with the Customer Code if you use a direct link in the Home Menu.
No Code	You can use all direct links in the Home Menu without login.

8 pH Control

8.1 View in the home display



Pos.	Content	Remarks
1	Module name "pH"	
2	Current pH measurement value	0.00...9.99 pH
3	Measurement graphic 	1 Lower alarm threshold 2 Current measurement reading 3 Setpoint 4 Upper alarm threshold
4	Current operating state	Auto / Off / Manual / Alarm (flashes!) / Flow / Power-on delay ("x min")
5	Pump symbol	The pump symbol rotates when the pump it represents is running.
	Current dosing direction	D- / D+
	Current dosing rate	0...100 pH
6	Alarms	All active alarms that pertain to the pH module are displayed. Alarms whose cause has been eliminated disappear from the display even if they have not yet been quit. If there are no active alarms, "OK" appears.

8.2 Configuration of pH Control

8.2.1 Setpoint, alarm limits, p-range

The pH control can be configured in the Commissioning menu or in the Customer menu under Measuring & Control (expanded parameter set for Service personnel) as described here.

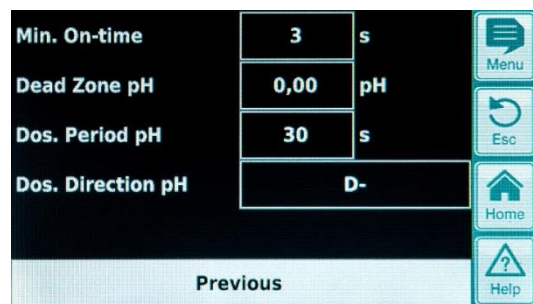
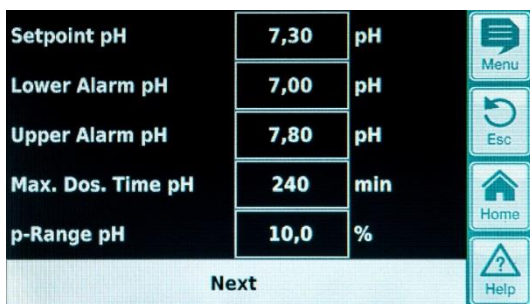

pH control settings		
Parameter	Description	
Setpoint pH	The desired pH value of the swimming pool water. It is recommended that you aim for a pH value of 7.2 since water disinfection is most effective at this level.	
Lower Alarm pH	The lower alarm threshold of the pH value. As soon as the pH value falls below the entered level, an alarm is output. The lower limit should lie 0.4 pH below the setpoint.	
Upper Alarm pH	The upper alarm threshold of the pH value. As soon as the pH value rises above the entered level, an alarm is output. The upper limit should lie 0.4 pH above the setpoint.	
Max. Dos. Time pH	The maximum duration for which an agent to raise or lower the pH value is dosed. If the set time is exceeded, an alarm is output and dosing of the agent is stopped.	
p-Range pH	The p-range setting. The p-range defines the response speed of the controller. As a rule: <ul style="list-style-type: none"> The smaller the percentage, the more product will be dosed. Advantage: the setpoint can be reached quickly. Disadvantage: the setpoint may not only be reached but may actually be exceeded. The larger the percentage, the less product will be dosed. Advantage: the setpoint is reached and is not exceeded. Disadvantage: the setpoint is reached more slowly. 	
Min. On-time	Minimum time for which the dosing pump is switched on. If the current deviation of the pH value requires a dosing time that is less than the set on time, dosing still takes place for the set on time.	
Dead Zone pH	The Dead Zone for the pH controller is set here. As long as the control deviation between setpoint and actual value lies within the Dead Zone, control remains inactive, i.e. there is no dosing. The control only starts dosing again when the control deviation moves outside the Dead Zone. When the reading moves (back) into the Dead Zone, the control remains active until the actual value reaches the setpoint.	
Dos. Period pH	The Dosing Period (or dosing cycle) for pH control is programmed here. Since the control uses pulse width modulation, the dosing period (i.e. the sum of the switched-on and switched-off time of the dosing relay) remains constant. The actual dosing rate is obtained from the variation in the ratio between the switched-on time and the switched-off time.	
Dos. Direction pH	D-	Only a dosing device to reduce pH is connected. The pH control operates in one direction only to reduce the pH level.
	D+	Only a dosing device to increase pH is connected. The pH control operates in one direction only to increase the pH level.
	(D+/D-)	Two dosing devices are connected to reduce or increase pH. The pH control operates in both directions to reduce or increase the pH level.

8.2.2 pH electrode calibration

The Pool Relax pH electrode must be calibrated once every three months to compensate for any deviations in its measurement behaviour. The electrode must be replaced once a year.

These maintenance and replacement intervals absolutely must be complied with to ensure that measurements are correct and that water quality is at its best.

As an example, the procedure for a 1-point calibration of the pH electrode is described here.

The 1-point calibration takes place in the main menu (customer). In this menu, select the Measuring & Control menu followed by the Calibration menu.

Procedure for the 1-point pH calibration:

- Dip the pH electrode in a buffer solution of pH 7.
- Wait until Current Value pH stabilises and remains constant.
- Under Cal. Value, enter 7.00 and confirm with "OK".
- Touch Next to start the calibration.
- The page that now appears shows the Electrode Slope and Offset parameters (zero shift). Although it is possible to adjust these values here, they do not need to be changed.
- Touch Ready to complete the calibration.

Alternatively, proceed as follows:

- Take a water sample from the pool and determine its pH value using a photometer. The measured value should lie around pH 7 to ensure that calibration will be correct.
- Dip the electrode into the measured sample. Wait until Current Value pH stabilises and remains constant.
- Under Cal. Value, enter the measured value and confirm with "OK".
- Touch Next to start the calibration.
- The page that now appears shows the Electrode Slope and Offset parameters (zero shift). Although it is possible to adjust these values here, they do not need to be changed.
- Touch Ready to complete the calibration.

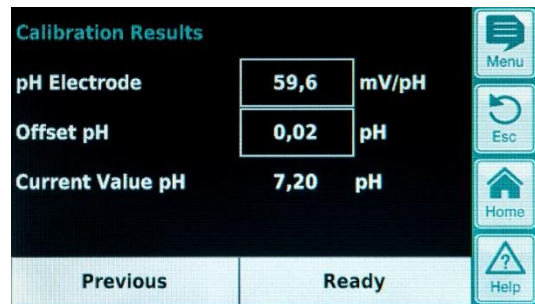
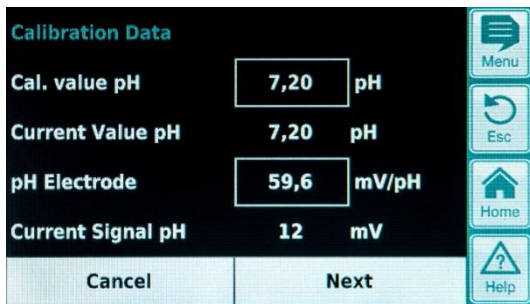

Parameter	Purpose	Setting
Calibration Parameters pH		
pH Electrode	Slope of pH electrode	Not required because this is an electrode constant
Offset pH	Zero shift of pH measurement	Not required because this is compensated by the calibration
1-Point Calibration pH - Calibration Input		
Cal. Value pH	pH reference value for calibration <ul style="list-style-type: none"> • pH 7 if using the buffer solution • pH value of water sample 	<ul style="list-style-type: none"> • 7.00 if using the buffer solution • pH value obtained from photometer
Current Value pH	Display of pH value currently measured	Measurement reading
pH Electrode	Slope of pH electrode	Calculated during calibration
Current Signal pH	Current deviation of pH measurement signal	Measurement reading
1-Point Calibration pH - Calibration Results		
pH Electrode	Slope of pH electrode	Calculated during calibration
Offset pH	Calculated offset pH	Calculated during calibration
Current Value pH	Display of pH value currently measured	Measurement reading

9 mV (redox) control

9.1 View in the home display

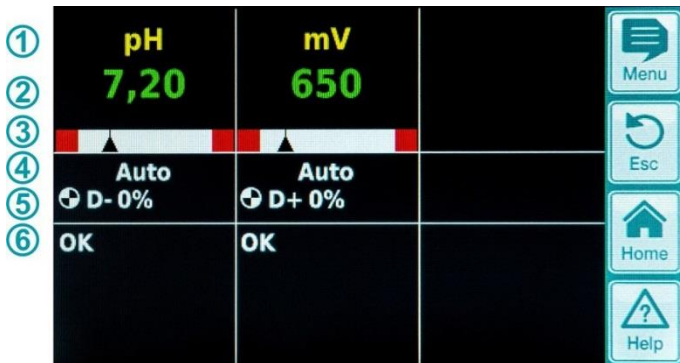

Pos.	Content	Remarks
1	Module name "mV"	
2	Current mV measurement value	0...999 mV
3	Measurement graphic	For a description, see "pH control"
4	Current operating state	Auto / Off / Manual / Alarm (flashes!) / Flow / Power-on delay ("x min")
5	Pump symbol	The pump symbol rotates when the mV (chlorine) dosing pump is running or the bromine dosing valve is switched on.
	Current dosing direction	D+ / D-
	Current dosing rate	0...100 % (a dosing rate of 50 % means that the dosing pump is running 50 % of the time)
6	Alarms	All active alarms that pertain to the mV (redox) module are displayed. Alarms whose cause has been eliminated disappear from the display even if they have not yet been quit. If there are no active alarms, "OK" appears.

9.2 mV (redox potential) configuration

9.2.1 Setpoint, limits, p-range

The redox (mV) control can be configured in the Commissioning menu or in the Customer menu under Measuring & Control (expanded parameter set for Service personnel) as described here.

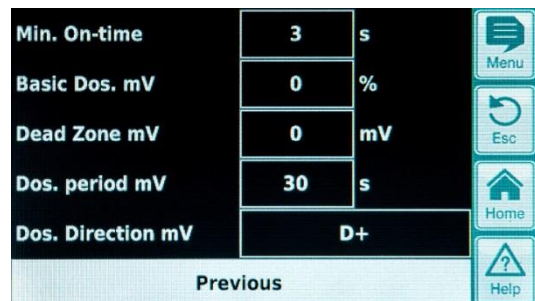

mV (redox potential) settings		
Parameter	Purpose / effect	
Setpoint mV	The desired or determined mV value of the swimming pool water. Initially, an approximation can be achieved by working with the preset default value. However, to precisely maintain the desired chlorine content in the swimming pool water, the value must be determined for that particular water.	
Lower Alarm mV	The lower alarm threshold of the mV value. As soon as the mV value falls below the entered level, an alarm is output.	
Upper Alarm mV	The upper alarm threshold of the mV value. As soon as the mV value rises above the entered level, an alarm is output.	
Max. Dos. Time mV	The maximum duration for which Chloriliquide is dosed. If the set time is exceeded, an alarm is output and dosing of Chloriliquide is stopped.	
p-Range mV	The p-range setting. The p-range defines the response speed of the controller. As a rule: <ul style="list-style-type: none"> The smaller the percentage, the more product will be dosed. Advantage: the setpoint can be reached quickly. Disadvantage: the setpoint may not only be reached but may actually be exceeded. The larger the percentage, the less product will be dosed. Advantage: the setpoint is reached and is not exceeded. Disadvantage: the setpoint is reached more slowly. 	
Min. On-time	Minimum time for which the dosing pump is switched on. If the current deviation of the mV value requires a dosing time that is less than the set on time, dosing still takes place for the set on time.	
Basic Dos. mV	Configuration of the basic dosing of the mV control. The mV controller always adds the basic dosing to the calculated dosing rate. The basic dosing compensates the natural attrition of dosed care products in the swimming pool water.	
Dead Zone mV	The Dead Zone for the redox controller is set here. As long as the control deviation between setpoint and actual value lies within the Dead Zone, control remains inactive, i.e. there is no dosing. The control only starts dosing again when the control deviation moves outside the Dead Zone. When the reading moves (back) into the Dead Zone, the control remains active until the actual value reaches the setpoint.	
Dos. period mV	The Dosing Period (or dosing cycle) for mV control is programmed here. Since the control uses pulse width modulation, the dosing period (i.e. the sum of the switched-on and switched-off time of the dosing relay) remains constant. The actual dosing rate is obtained from the variation in the ratio between the switched-on time and the switched-off time.	
Dos. Direction mV	D+	A dosing device for chlorine, bromine or Bayrosoft® is connected to increase the redox (mV) value. The redox control operates in one direction only to increase the redox level. This is the normal way of operation.
	D-	A dosing to reduce the redox (mV) value is connected. This setting may only be used in special situations to reduce the chlorine or bromine level in the pool.

9.2.2 Redox electrode calibration

The Pool Relax redox electrode must be calibrated once every three months to compensate for any deviations in its measurement behaviour. The electrode must be replaced once a year.

These maintenance and replacement intervals absolutely must be complied with to ensure that measurements are correct and that water quality is at its best.

As an example, the procedure for a 1-point calibration of the redox electrode is described here.

The 1-point calibration takes place in the main menu (customer). In this menu, select the Measuring & Control menu followed by the Calibration menu.

Procedure for the 1-point redox calibration:

- Dip the electrode in a buffer solution of 465 mV.
- Wait until Current Value mV stabilises and remains constant.
- Under Cal. Value, enter 465 and confirm with "OK".
- Touch Next to start the calibration.
- The page that now appears shows the Electrode Slope and Offset parameters (zero shift). Although it is possible to adjust these values here, they do not need to be changed.
- Touch Ready to complete the calibration.

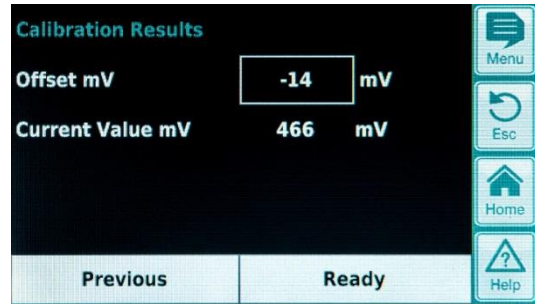

Parameter	Purpose	Setting
1-Point Calibration mV – Calibration input		
Cal. Value mV	mV reference value for calibration	465 if using the 465 mV buffer solution
Current Value mV	Display of pH value currently measured	Measurement reading
1-Point Calibration mV - Calibration Results		
Offset mV	Calculated offset mV	Calculated during calibration
Current Value mV	Display of mV value currently measured	Measurement reading

10 Temperature measurement

10.1 View in the home display

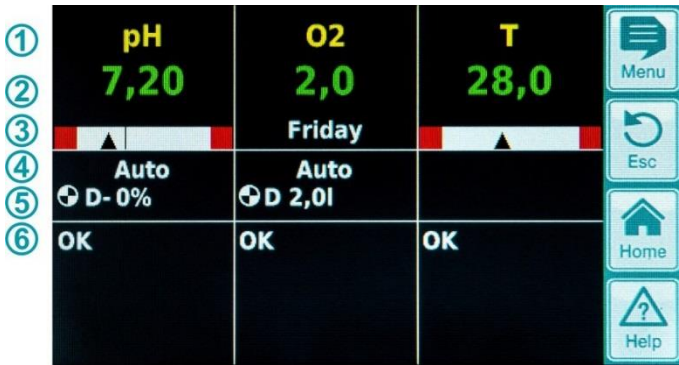

Pos.	Content	Remarks
1	Module name "T"	
2	Current temperature measurement value	0.0...99.9 °C
3	Measurement graphic	For a description, see "pH control". There is no setpoint display since the temperature is only measured.
6	Alarms	All active alarms are displayed that pertain to the temperature measurement (upper and lower threshold alarm). Alarms whose cause has been eliminated disappear from the display even if they have not yet been quit. If there are no active alarms, "OK" appears.

10.2 Temperature configuration

For the Pool Relax Chlorine and Pool Relax Bromine the temperature measurement is unused. For the Pool Relax Oxygen, temperature measurement is active and used for the calculation of the temperature compensation (refer to the description of the O2 module).

The lower and upper alarm thresholds can be set in the menu.

You can also deactivate temperature measurement and temperature display by setting "Temperature Sensor = None" or activate it by selecting the standard "PT1000" temperature sensor or the alternative KTY83 version.

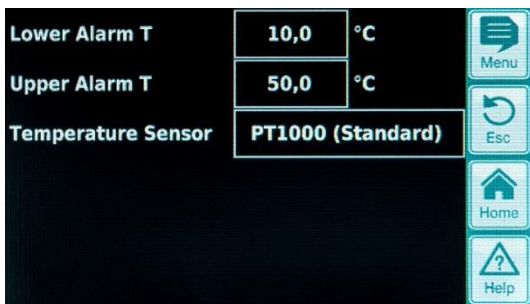

11 Automatic dosing system O2 (Bayrosoft®)

11.1 View in the home display

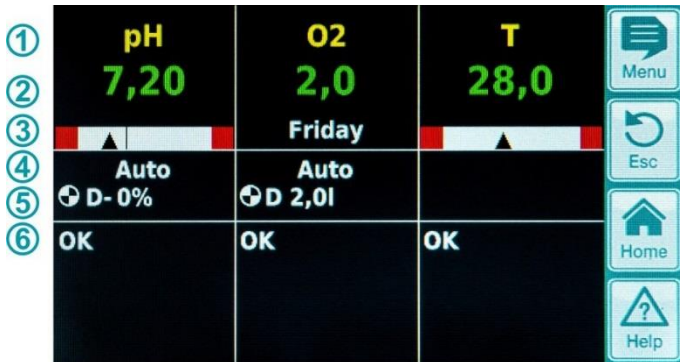

Pos.	Content	Remarks
1	Module name "O2"	
2	Programmed dose amount	The dosed quantity is displayed here during dosing, i.e. the display increases steadily from 0.0 litres until it reaches the total dosed amount. After dosing is completed, the display returns to the programmed dose amount.
3	Main dosing day	Monday, Tuesday, ...
4	Current operating state	Auto / Off / Alarm (flashes!) / Flow / Power-on delay ("x min") / Dosing (display of time remaining in "x min" minutes)
5	Pump symbol	The pump symbol rotates when the O2 (Bayrosoft®) pump is running.
	Current dosing direction	D for automatic dosing or M for manual dosing (M = "manual")
	Current dose amount (or programmed dose amount)	While dosing is in progress, the total dosed amount of the current dosing is displayed here (main dosing, intermediate dosing or manual dosing). After dosing is completed, the display returns to the programmed dose amount.
6	Alarms	All active alarms that pertain to the O2 module are displayed. Alarms whose cause has been eliminated disappear from the display even if they have not yet been quit. If there are no active alarms, "OK" appears.

11.2 O2 (Bayrosoft®) menu

The O2 menu consists of four submenus:

- **Configuration O2 (Bayrosoft®)**
For setting all relevant parameters for the O2 automatic dosing system.
- **Average temperature**
Display of the average measured temp. for the entire week and for each individual third of the week.
- **Date & time**
For checking and, if necessary, correcting the setting of the current weekday, date and time.
- **Planned dosings**
Display of the next planned dosings with date and time.
The main dosing and the two intermediate dosings are displayed.
 - If necessary, dosage planning can be reset in this menu.
In this case, the current planning is discarded and a re-planning is created based on the current weekday and date.
 - Note: Additional dosings are NOT displayed.
- **Additional dosings**
For configuring the additional dosings as described below.

11.2.1 Configuration and Settings O2 (Bayrosoft®)

The following parameter settings are available:

Parameter	Value range	Standard settings (default)
Temp. Compensation	Off / Normal / High	Normal
	The temperature compensation should be set to "High" if the amount of Bayrosoft® added during the intermediate dosings proves to be too low.	
Hose Config. O2	1,5 l/h / 3 l/h / ...	3 l/h
	The dosing rate of the Bayrosoft® pump is entered here. This setting must match the actual pump rate of the pump in use. Otherwise, Pool Relax will be unable to correctly calculate the required pumping duration for a dosing and the dosed Bayrosoft® amounts will be incorrect.	
Pool Volume	1...5000 m ³	40 m ³
	When the pool volume is entered, the Bayrosoft® dose amount is automatically adjusted to the pool size (0.5 litres per 10 m ³ of pool volume).	
Dose Amount O2	0.0...99.9 l	0.5 litres per 10 m ³ of pool volume (e.g. 2.0 l for 40 m ³ of pool volume)
	The basic dose amount for the O2 automatic dosing system is specified here. The standard value derived from the pool volume can be adjusted again. The actual dose amount of the main dosing and the two intermediate dosings depends on the measured water temperature.	
Dosing Day O2	Monday...Sunday	Friday
	Weekday of the main dosing.	
6s Dosing	Active / inactive	Active
	After Pool Relax is switched on and no later than after 12 hours of operation, the Bayrosoft® pump is started briefly for approx. 6s to prevent product deposits.	

11.3 Basic principles

The optimal amount of Bayrosoft® is added to the swimming pool water in several automatic dosings per week.

The dosed amount depends on the dose amount programmed on the device and on the measured water temperature. The recommended setting for the dose amount is 0.5 litres per 10 m³ of pool volume.

11.4 Main dosing

The main dosing takes place on a specific day of the week, the so-called main dosing day. The amount of Bayrosoft® that is dosed corresponds to the programmed dose amount. Depending on the measured water temperature, the actual dosed amount may be increased by a certain factor. This mechanism is referred to as temperature compensation. The dose amount is corrected to compensate for the increasing attrition of the care product at higher temperatures.

The factor by which the programmed dose amount is increased is shown in the following table:

	Average temperature of the preceding week									
	≤ 24 °C	25 °C	26 °C	27 °C	28 °C	29 °C	30 °C	31 °C	32 °C	>32 °C
Factor	1.00	1.06	1.10	1.15	1.20	1.28	1.40	1.57	1.80	2.00

- For water temperatures below 24 °C, there is no temperature compensation.
- For water temperatures above 32 °C, double the programmed dose amount is added.

Example:

For a programmed dose amount of 2.0 litres at a water temperature of 28 °C:

Main dose amount = 2.0 litres x factor 1.20 = 2.40 litres

Main dosing takes place on the programmed day of the week at midnight. If the flow signal is missing (e.g. because circulation has been switched off) or if there are alarms, main dosing will be delayed.

11.5 Intermediate dosing

In the course of the week that passes until the next main dosing, the amount of effective Bayrol in the water will decrease steadily. Product attrition accelerates at higher temperatures. To compensate these effects and to ensure that the optimal amount of Bayrol is always in the water, intermediate dosing takes place after the first third and the second third of the week.

The dose amount of the intermediate dosings depends on the following factors:

- Programmed dose amount
- Measured water temperature (for the preceding third of the week)
- Temperature compensation setting (off / normal / high)

If temperature compensation is switched off, intermediate dosing does not take place.

If temperature compensation is switched on, the dose amount of the intermediate dosing is calculated by multiplying the programmed dose amount by a temperature-dependent factor.

	Average temperature of the preceding third of the week				
	≤ 24 °C	24-26 °C	26-28 °C	28-30 °C	> 30 °C
Factor for "Normal" temp. compensation	0	0.1	0.2	0.3	0.4
Factor for "High" temp. compensation	0	0.2	0.4	0.6	0.8

At temperatures below 24 °C, intermediate dosing does not take place (factor = 0).

Example:

For a programmed dose amount of 2.0 litres, the actual dose amount at a water temperature of 28 °C and the "Normal" temperature compensation is:

Intermediate dose amount = 2.0 litres x factor 0.2 = 0.4 litres

For the "High" temperature compensation setting, the actual dose amount is:

Intermediate dose amount = 2.0 litres x factor 0.4 = 0.8 litres

The first intermediate dose takes place two days after the programmed dosing day at 8:00 a.m.

The second intermediate dose takes place four days after the programmed dosing day at 4:00 p.m.

If the flow signal is missing (e.g. because circulation has been switched off) or if there are alarms, intermediate dosings will be delayed.

Example:

If the dosing day is set to "Friday", the following dosing times apply:

- Main dosing on Fridays at 00:00
- First intermediate dosing on Sundays at 08:00
- Second intermediate dosing on Tuesdays at 16:00

11.5.1 Trend of effective Bayrosoft® concentration in water

The following figures show the trend of the effective Bayrosoft® concentration in water over the course of one week.

In the first example, the water temperature is 24 °C. Therefore, intermediate dosing does not take place.

In the second example, the water temperature is 28 °C. Therefore, two intermediate dosings temporarily raise the effective Bayrosoft® concentration in the water.

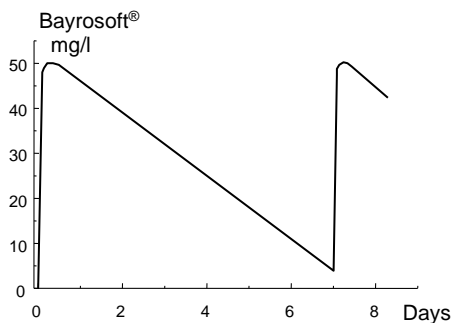

Automatic dosing at 24 °C
(Trend of the Bayrosoft®
concentration over one week)

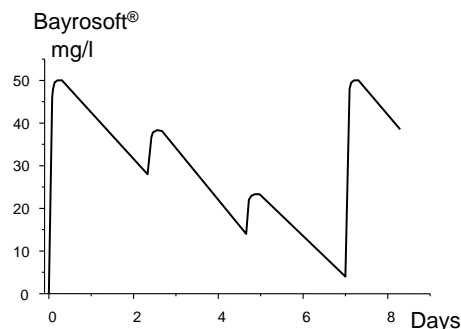

Automatic dosing at 28 °C
(with two intermediate dosings)

11.6 Additional dosings

In addition to the automatic mode with temperature compensation, Pool Relax can be used to program other additional dosings.

The additional dosings are supplementary to the main dosing and the intermediate dosings. The dose amount of the additional dosings is fixed as programmed and is not temperature-compensated.

The following parameters for the additional dosings can be set in the "Additional Dosages" menu:

Parameter	Explanation
Days of Week	Here you can select the days of the week on which the additional dosings are to take place (one or more). Default: off
Time	Start time of the additional dosings (the same for all weekdays). Default: 00:00 hours
Dose Amount	Dose amount of the additional dosings (the same for all weekdays). Default: 0.2 l

Example

The system is to be configured so that 2.5 l of Bayrosoft® are dosed on Fridays and 2.0 l both on Mondays and on Wednesdays. Temperature compensation is not desired.

The following settings are required:

In the "Configuration O2 (Bayrosoft®)" menu:

- Dose amount O2 = 2.5 l
- Temp. compensation = Off
- Dosing day O2 = Friday

In the "Additional Dosages" menu:

- Days of week = Monday, Wednesday, ...
- Dose amount O2 = 2.0 l

If temperature compensation is activated, the main dosing is temperature-compensated and the two intermediate dosings take place if programmed.

12 Alarm monitoring

12.1 Overview

Pool Relax continuously monitors all relevant data and operating states to ensure correct operation and good water quality.

If Pool Relax discovers a problem, it generates an alarm message that points to the problem. Some alarm conditions block product dosing until the alarm is eliminated.

The following alarm conditions are monitored by Pool Relax.

Alarm	Is activated, ...	Blocking of dosing	Remarks
Upper Alarm (pH, mV)	if a measurement value lies above the upper alarm limit.	Only in dosing direction D+ (for the corresponding module only)	Blocking is cancelled as soon as the measured value drops below the upper alarm limit
Lower Alarm (pH, mV)	if a measurement value lies below the lower alarm limit.	Only in dosing direction D- (for the corresponding module only)	Blocking is cancelled as soon as the measured value rises above the lower alarm limit
Flow Alarm (Automatic Quitting)	if there is no measurement water flow.	Yes (for all control modules)	When the flow signal returns, the power-on delay runs down. After it elapses, dosing is re-enabled. The alarm does not have to be quit.
Flow Alarm (Manual Quitting)	if there is no measurement water flow.	Yes (for all control modules)	When the flow signal returns <i>and</i> the alarm is quit, the power-on delay runs down. After it elapses, dosing is re-enabled.
Level Alarm (pH, mV, O ₂)	if a pool care product canister (pH minus, Chloriliquide, Bayrosoft®) is empty (the suction lance in the product canister issues a canister empty signal)	Yes (for all control modules) can be deactivated in the "Alarm Settings" menu	When the level signal returns, dosing is re-enabled.
Dosing Time Alarm (pH, mV)	if despite continuous dosing, Pool Relax is not able to achieve the desired setpoint within the specified time. In this case, Pool Relax assumes that there may be a problem and blocks any further dosing.	Yes (for the corresponding module only)	After the dosing time alarm is quit on the alarm page, dosing is re-enabled.
Power-on Delay		Yes (for the corresponding module only)	The power-on delay elapses after Pool Relax is switched on and after a flow alarm. When the time has elapsed, dosing is enabled. The power-on delay can be ended prematurely by quitting.
Battery alarm	if the voltage of the buffer battery installed in the Pool Relax device falls below a limit value of 2.70 V.	No	The buffer battery supplies the real-time clock and the non-volatile memory of Pool Relax when the device is shut off.

Note:

All alarms are displayed with an alarm delay of 5 s.

Likewise, they are only deleted if the alarm cause has been eliminated for at least 5 s.

The alarm delay for the flow alarm can be extended in the "Alarm Settings" menu.

12.2 Flow alarm

Pool Relax offers two different variants for monitoring the flow alarm.

12.2.1 Automatic quitting of the flow alarm (default variant)

In this variant, Pool Relax evaluates a flow alarm not as a fault but as a normal operating state. In most swimming pool systems, circulation does not take place around the clock but is only switched on intermittently. In this case it is normal for Pool Relax not to receive a flow signal during times when there is no circulation.

Accordingly, Pool Relax signals the missing flow signal as a normal operating state and not as an alarm condition. The special mechanism for signalling alarms is not activated (flashing display, acoustic alarm, etc.).

Dosing is blocked as long as there is no flow signal. After the flow signal returns and after the power-on delay elapses, Pool Relax automatically returns to its normal control mode.

12.2.2 Manual quitting of the flow alarm

This variant is only intended for swimming pools in which circulation runs twenty-four hours a day without interruption. Pool Relax evaluates a missing flow signal as a serious fault condition that is signalled by various alarm mechanisms.

Important: Even after the flow signal is restored, dosing remains blocked in this variant. Blocking is only cancelled after the flow alarm is manually quit **and** the flow signal is restored.

12.2.3 Monitoring of the measuring water

The flow of measuring water is permanently monitored with a sensor, which is installed in the measuring chamber. The flow of water moves the float up to the level of the sensor. The monitoring of the flow of measuring water cannot be deactivated. Dosing is blocked, if there is no flow signal to prevent dosing into non-circulating water.

12.3 Power-on delay

After the Pool Relax device is switched on or after a flow alarm, the adjustable power-on delay time runs down. Pool Relax waits for this time to elapse to give all measurement values time to stabilise. Dosing does not take place during the power-on delay. Normal control mode only begins after the power-on delay has elapsed.

The power-on delay is displayed on the alarms page as follows:

Power-on delay	5	min
Power-on delay	Quit	

The first line shows the time remaining of the power-on delay.

The second line lets you end the power-on delay prematurely by activating the quit button.

12.4 Alarm signalling

Pool Relax signals the alarm condition to the user by various mechanisms.

- **Noticeable flashing of the entire display**
The flashing stops as soon as you touch the screen.
- **Automatic jump to the "Alarms" menu**
The "Alarms" menu can be called up any time directly from the selection menu via the menu button.
- **Acoustic alarm signal**
(provided that this function is activated for the respective alarm in the "Alarm Settings" menu)
The acoustic alarm signal stops as soon as you touch the screen.
- **Switching of the alarm relay**
(potential-free switch output (max. 230 VAC / 8 A) for connecting external systems for the signalling or recording of alarm conditions (connecting terminal 45/46))
- Alarm display in home display

The alarms are displayed on the alarm page as follows:

Level Alarm pH	Quit
-----------------------	-------------

A new alarm occurred. The alarm cause has not yet been eliminated.

The alarm has also not been quit, which is why the quit button is displayed.

Level Alarm pH

The alarm cause has not yet been eliminated.

The alarm has already been quit, which is why the quit button is not displayed.

(Level Alarm pH)	Quit
-------------------------	-------------

The alarm cause has already been eliminated, which is why the alarm appears in parentheses.

However, the alarm has not yet been quit, which is why the quit button is displayed.

When the alarm cause has been eliminated *and* the alarm has been quit by the user, it completely disappears from the alarm page.

The quit button does not appear for the flow alarm if "Automatic Quitting" is set.

12.5 Blocking of dosing by alarms

Alarms generally result in dosing being blocked. Blocking is automatically cancelled when the alarm cause is eliminated. The alarm does not have to be quit by the user to end the blocking.

The following alarms are an exception to this rule:

- If "Manual Quitting" is set for the flow alarm, blocking of dosing is ended when the flow signal returns *and* the flow alarm was quit by the user. Dosing is resumed after the power-on delay has elapsed.
- If "Automatic Quitting" is set, blocking of dosing is ended when the flow signal returns. Dosing is resumed after the power-on delay has elapsed.
- In the "Alarm Settings" menu, it can be specified whether a level alarm should block dosing. By default, a level alarm blocks dosing of the corresponding control module (pH, mV, O₂).
- After the dosing time alarm, dosing is enabled again when the alarm is quit.

12.6 Alarm settings

The following adjustments can be made in the "Alarm Settings" menu:

12.6.1 Acoustic alarms

The following acoustic alarms can be activated and deactivated individually:

- Acoustic signal for flow alarm
- Acoustic signal for level alarm
- Acoustic signal for other alarms
- Acoustic signal for service messages

12.6.2 Flow alarm settings (in Service menu only)

- Duration of power-on delay
- Alarm delay for the flow alarm
- Quitting of the "Automatic" or "Manual" flow alarm

12.6.3 Level alarm settings (in Service menu only)

- Level alarm pH active/inactive
(level alarm can be deactivated if no empty signal is present)
- Level alarm mV/Cl or O₂ active/inactive
(level alarm can be deactivated if no empty signal is present)
- Dosing in case of level alarm yes/no
(if the empty signal occurs before the canister is completely empty, dosing can be continued despite the level alarm)

13 Service messages

13.1 Overview

The Service Messages function enables precise planning of certain service procedures:

- **Calibration (pH, mV, T)**
Recommended interval: pH, mV 3 months / temperature 12 months
- **Electrode replacement (pH, mV)**
Recommended interval: 12 months
- **Hose replacement at dosing pump (pH, mV, O₂)**
Recommended interval: 12 months

For each service procedure, a time interval in months can be specified in the "Service Intervals" menu (only in the Service menu). After this period, Pool Relax automatically reminds you that the planned service procedure is due.

By default, all service intervals are set to 0 months and are thus deactivated. To activate this function, an interval of 1...60 months must be set for the required service procedures. The service message can be deactivated at any time by resetting the value to 0 months.

In the "Service Messages" menu, which can be opened directly from the selection menu, all planned service procedures are displayed with their due date. If necessary, the planning date calculated by Pool Relax can be changed manually.

A service procedure is displayed as follows:

Calibration pH	09.11.2017
-----------------------	-------------------

The pH calibration is due on 09.11.2017.

When the due date is reached, the quit button appears instead of the planning date:

Calibration pH	Quit
-----------------------	-------------

When the quit button is activated, the procedure is re-planned and the newly calculated due date is displayed.

13.2 Signalling of due service messages

Service messages that are due are indicated as follows:

- **Noticeable flashing of the entire display**
The flashing stops as soon as you touch the screen.
- **Automatic jump to the "Service Messages" menu**
The "Service Messages" menu can be called up any time directly from the selection menu via the menu button.
- **Acoustic alarm signal**
(provided that this function is activated in the "Alarm Settings / Acoustic Alarms" menu)
The acoustic alarm signal stops as soon as you touch the screen.

Note:

Service procedures that are due are indicated on the respective day beginning at 08:00.

13.3 Re-planning of service messages

Pool Relax determines the due date of a service message by adding the set service interval to the current date.

Example:

A service interval of 3 months is set for pH calibration.

A re-planning takes place on 06.12.2017.

The new due date is 06.03.2018.

Service message are re-planned in the following cases:

- Change in the service interval in the "Service Intervals" menu
- Activation of the quit button of a message that is due
- Successful performance of a calibration
(for calibration message only)
- The "Re-plan service message" function is opened in the "Service Intervals" menu

14 Event log

14.1 Overview

The event log records all important events concerning Pool Relax. It is an important aid in monitoring the correct operation of the swimming pool system and analysing possible problems.

The event log can be opened from the main menu. It records up to 100 events with date and time.

The following events are recorded:

- Switching on and off of Pool Relax
- Alarm conditions (beginning and end)
- Calibration
- Parameter changes
- O2 dosing
- Default resets

Since all entries are displayed by Pool Relax in easily comprehensible text, a detailed depiction of the individual events will not content be provided here.

The following example illustrates the contents of the event log:

- 1 06.06.2017 08:44**
Main dosing O2 ended (2.4/2.4l)
- 2 06.06.2017 08:30**
Main dosing O2 continued (1.0/2.4l)
- 3 06.06.2017 08:30**
(Level alarm O2) end
- 4 06.06.2017 08:10**
Main dosing O2blocked (level)
- 5 06.06.2017 00:10**
Level alarm O2
- 6 06.06.2017 00:00**
Main dosing O2 started (2.4l)

This sequence in the event log has the following background:

At midnight, Pool Relax starts an O2 main dosing with a dose amount of 2.4 litres. After 10 minutes, the Bayrosoft® canister is empty. This causes a level alarm that blocks the O2 main dosing. The next morning at 8:00 a.m., the empty Bayrosoft® canister is replaced. The level alarm ends and the O2 main dosing is continued, where 1.0 litre of Bayrosoft® had already been dosed prior to the level alarm. Thus, only an additional 1.4 litres must be dosed. At 8:44 a.m., the O2 main dosing is ended as planned after the full amount of 2.4 litres was dosed.

15 Manual dosing

15.1 Overview

For the pH, mV and O2 modules, an additional amount of care product can be added to the swimming pool water at any time by means of manual dosing.

Manual dosing is time-limited and is automatically ended after the selected dosing duration. In addition, manual dosing can be stopped any time. During manual dosing, the dosing pump runs continuously, i.e. at a dosing capacity of 100 %.

15.2 "Manual Dosage" menu

A manual dosing can be started in the "Manual Dosage" menu.

The following settings are available:

Parameter	Value range	Standard settings (default)
Current Measured Value		
pH / mV	D- / D+	D-
Man. Dos. Direction	The dosing direction of the manual dosing can be selected if the pH control works in both directions. If dosing works in only one direction, manual dosing always takes place in the configured dosing direction (in the "Measuring & Control" menu).	
Hose Config.	1,5 l/h / 3 l/h / ...	pH / mV: 1,5 l/h O2: 3 l/h
	The dosing rate of the corresponding Bayrosoft® pump is entered here. This setting must match the actual pump rate of the pump in use. Otherwise, Pool Relax will be unable to correctly calculate the required pumping duration for a manual dosing and the dosed amount of Bayrosoft® may be incorrect.	
pH / mV / O2	0.1...10.0 l	1,5 l (for O2: single main dose amount)
	The desired dose amount for the manual dosing is entered here. Pool Relax calculates the duration of the manual dosing from the dose amount and the hose configuration. Example: For a hose configuration of 3 l/h and a dose amount of 2.0 l, the duration of manual dosing is 40 min.	
Manual Dos. Amount	1...240 min	60 min
	The duration of the manual dosing can be specified here. If the setting is changed, the Pool Relax also recalculates the dose amount on the basis of the hose configuration. Example: For a hose configuration of 1,5 l/h and a duration of manual dosing of 90 min, the dose amount is 2,25 l.	

Activating the "Start Manual Dosage" button starts dosing.

Note:

Aside from manually entering the desired dose amount, a single, double or triple dose of the basic dose amount can also be selected in manual dosing O2 (Bayrosoft®).

During dosing, the menu display changes. Only the data relevant to the dosing in progress are displayed:

- Current measured value pH / mV
- Remaining time of manual dosing in minutes
- The amount already dosed in litres for the manual dosing in progress.
- Current dosing rate in %
Only the values 0 % or 100 % can appear here. If a dosing rate of 0 % is displayed, manual dosing is blocked by an alarm.
- Pump (on / off)
The current status of the dosing pump in use. If "Pump off" is displayed, manual dosing is blocked by an alarm.
- Operating state pH / mV / O₂ (Manual / Flow / Alarm)
While dosing is in progress, Pool Relax is in the "Manual" operating state.
If "Alarm" or "Flow" is displayed instead, manual dosing is blocked by an alarm.

By activating the "Stop Manual Dosage" button, manual dosing can be stopped at any time.

15.3 Blocking by alarms

Manual dosing is blocked by the following alarm conditions, as is normal automatic dosing:

- Missing flow signal
- Level alarm (depends on the configuration in the "Alarm Settings" menu)
- Upper alarm (only blocks manual dosing in the D+ dosing direction)
- Lower alarm (only blocks manual dosing in the D- dosing direction)

After the end of the alarm condition, manual dosing is unblocked and the remaining amount is dosed.

If manual dosing is started during the power-on delay, this prematurely ends the power-on delay.

15.4 Special case of shock chlorination

Shock chlorination is a special variant of manual dosing. Pool Relax offers the shock chlorination option in the "Manual Dosage" menu under the following circumstances:

- The device is a Pool Relax CI unit
- The dosing direction is set to D+

The dose amount of the shock chlorination is calculated using the pool volume. The calculation is based on a recommended amount of 0.2 litres of Chloriliquide per 10 m³ pool volume.

The dose amount calculated in this way can be changed manually.

Activating the "Start Shock Chlorination" button starts dosing.

The shock chlorination procedure corresponds exactly to a normal manual dosing.



A shock chlorination is permitted to exceed the upper alarm limit.
It is not blocked by an upper alarm.

15.5 Special case of pump test (pH / mV / O₂)

The Pump Test function is used to quickly test whether the individual dosing pumps are connected correctly and are fully functional.

The duration of the pump test is limited to 5 minutes at the most.



Alarms do not cause blocking during a pump test, i.e. the pump must run during a pump test.
The pump test procedure corresponds exactly to a normal manual dosing.

16 Add-on Modules

16.1 Universal switch outputs

16.1.1 Overview

Pool Relax offers up to four universal switch outputs that can be used to control additional attractions, e.g. pool illumination or a jet system.

The terminals „OUT1“ or „OUT2“ are used for the switching functions. In addition to that, the outputs „OUT3 (pH+)“ and „OUT4 (Alarm)“ can also be used for switching functions, if they are not needed for pH+ dosing or as alarm relay, respectively.



Electrical Hazard!

The universal switching outputs provide volts-free contacts, i.e. there are simple on/off contacts between the two terminals of „OUT1“, „OUT2“, „OUT3 (pH+)“ and „OUT4 (Alarm)“.

The Pool Relax does not supply 230 V~ to these terminals

The maximum switching voltages and currents for these contacts are as follows:

OUT1 / OUT2 / OUT4 (Alarm):

- Max. 230 V~ / 4 A (AC)
- Max. 30 V= / 4 A (DC)
- No internal fuse – External electrical protection is mandatory!

OUT3 (pH+):

- Max. 230 V~ / 4 A (AC)
- Max. 30 V= / 4 A (DC)
- Internal fuse 4 A slow
- You can place a wire bridge to the neighbouring „L1“ terminal to use the OUT3 output as a 230 V~ output

The installation must be done by a professional electrician!

16.1.2 Programming the switch outputs

The switch outputs are programmed in the manner of an easy-to-operate timer. For every switch output there are up to three switching intervals.

The following settings can be made for each of these switching intervals:

- Switch-on time (time in hh:mm format)
- Switch-off time (time in hh:mm format)
- Selection of weekdays on which the respective switching interval is to be active.
One or more weekdays can be selected.
If no weekday is selected, the switching interval is inactive.

This concept permits a very flexible use of the universal switch outputs.

The following example illustrates this:

- Switch interval 1: 07:00 to 08:00, on every weekday
- Switch interval 2: 13:00 to 15:00, Saturdays and Sundays
- Switch interval 3: 18:00 to 20:30, Wednesdays

The corresponding switch output is activated daily from 7 a.m. to 8 a.m. and additionally on Saturdays and Sundays from 1 p.m. to 3 p.m. and on Wednesdays from 6 p.m. to 8:30 p.m.

16.1.3 Manual mode

The two universal switch outputs of Pool Relax can be manually switched on and off permanently (operating mode "On" or "Off"). In this case, time control is deactivated.

16.1.4 Other Operating Modes

- Heating**
 The output is activated if the current temperature reading is below a heating setpoint temperature, that can be entered. In order to prevent, that the heating output switches on and off in case of minor temperature changes, a switching hysteresis can be defined.
- Dosage pH- / pH+ / Disinfection**
 The output is switched on and off at the same time as the selected dosing output. Both outputs are synchronized. This allows switching on a second device in parallel with the dosing pump.
- Extra pump Cl (Pool Relax Chlorine only)**
 The output is switched on as long as chlorine is being dosed, i.e. as long as the mV (redox) dosing rate is not at 0%. In this mode, you can also set a follow-up time (0...120 minutes). When chlorine dosing stops, the "Extra pump Cl" output continues to be switched on for the follow-up time.
- Alarm Relay (OUT4 only)**
 The switch output 4 can be used as alarm relay, i.e. it is activated as long as there are active alarms. This is the default function of OUT4.

16.1.5 Blocking by flow

Blocking by the flow signal can be activated for both switch outputs. If blocking by flow is switched on, the respective switch output is only switched on if the flow signal is present. If the flow signal is missing (such as during power-on delay), the switch output is not switched on.

As a special case, it is possible to set the operating mode to "On" and to switch on blocking by flow. In this case, the respective output is always switched on when a flow signal is present. If the flow signal is not present, the output is switched off.

16.1.6 Level Alarm IN1 / IN2

If the Level Alarm is activated ("on") the corresponding output OUT1 / OUT2 is blocked, if the input IN1 / IN2 is open and a level alarm IN1 / IN2 is signalled. This option can be used for level monitoring, if an output is used to control a Flockmatic® pump.

16.1.7 Display in the Home Menu

You can display either of the four switching functions in the Home Menu, if you set "Show in Home = Yes" for the individual functions.

The following example shows the display of three switching functions in the Home Menu:

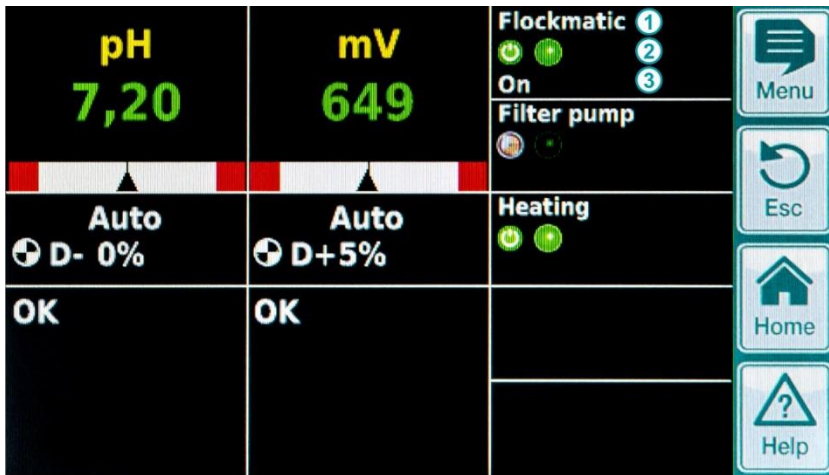

No.	Position	Description
1	First line	Name of the switching function (entered by the user in the configuration menu)
2	Second line	Symbols indicating the current status of the function ⏻ The function is in an active mode ⏹ The function is in an inactive mode ⌚ The function is in time controlled mode ● The output relay of the function is switched off at the moment ● The output relay of the function is switched on at the moment
3	Third line	Optional additional information, e.g. mode of operation or the cause in case of blocking.

16.1.8 Application examples

16.1.8.1 Control of a 230 V device

A 230 V device is connected between neutral N (blue) and phase L (brown) of the power supply, between which there is a voltage of 230 VAC (AC voltage). A protective conductor is generally present as well (yellow/green).

If a device of this type is to be controlled via a universal switch output of Pool Relax, it must be connected as follows:

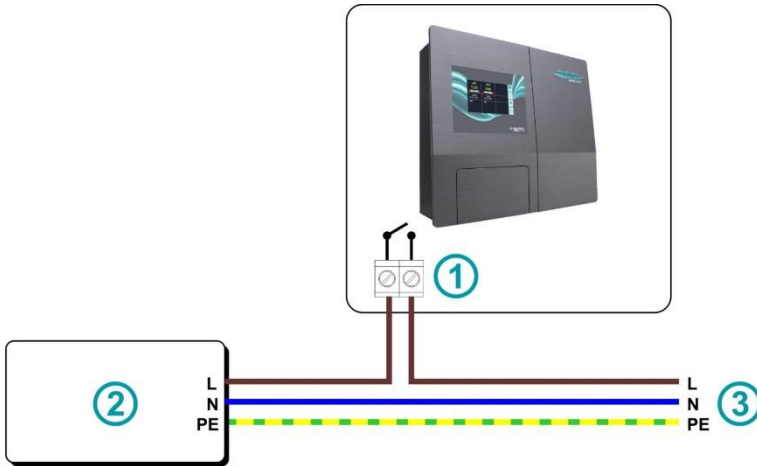

1	Output OUT1 / OUT2 terminal
2	External 230 V~ device to be switched on and off
3	House mains supply

Note: The 230 V~ supply voltage can be picked up internally from the connection compartment of Pool Relax and wired to the controlled device.

For example, a **Flockmatic® pump** or a **filtering system** can be controlled according to this scheme.

If the maximum current or voltage of the universal switch output should be inadequate for a certain application, an external relay with the required performance characteristics can be connected.

16.1.8.2 Control of a device with a DC supply voltage (DC)

For devices with a DC supply voltage, the positive line of the supply voltage is simply connected via the universal switch output of Pool Relax:

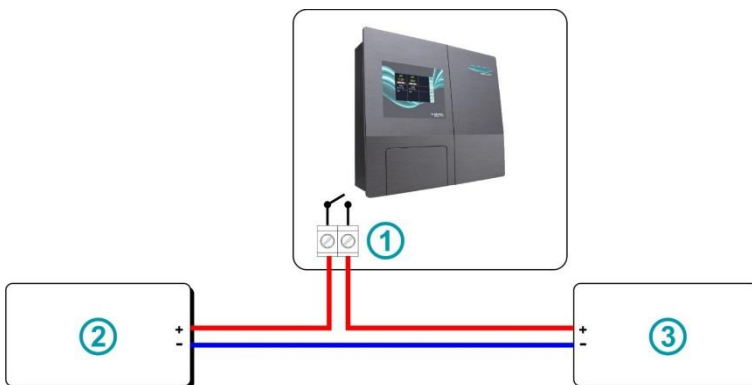

1	Output OUT1 / OUT2 terminal
2	External device (e.g. 24 V device) to be switched on and off
3	External power supply (e.g. 24 V supply)

16.1.8.3 Control of a device with a potential-free control input

Some devices have a potential-free control input. The input can be connected directly to the universal switch output of Pool Relax:

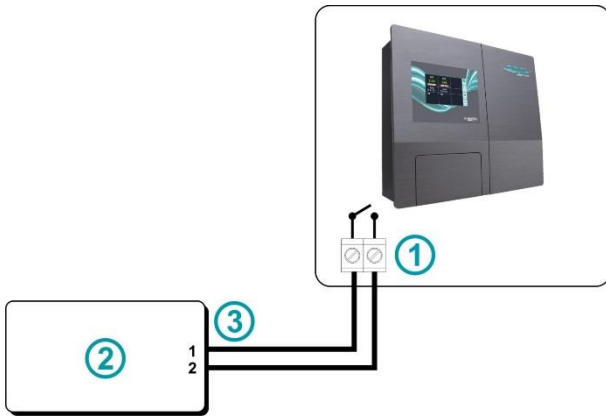

1	Output OUT1 / OUT2 terminal
2	External device with volts-free control input to be switched on and off
3	Control Input for volts-free switching contact

If an input of this type is available, it should be used whenever possible instead of switching the power supply of the device on and off.

16.2 Mounting of an additional cable feed-through

An additional cable feed-through must be created in order to connect an external device (e.g. lighting) or an external sensor (e.g. paddle flow switch) to the Pool Relax. There are push-outs on the bottom and sides of the front housing cover of the Pool Relax for this purpose.

Proceed as follows:

- Select the push-out closest to the connecting terminal you wish to use.
- Press from the inside against the centre of the push-out until you can see the round shape on the outside of the housing. Now press from the outside against the centre of the circle. Repeat this step until the circular push-out is detached, leaving a round hole. If the hole is not perfectly circular, you can round it off carefully using a suitable file.
- Now place the cable gland in the hole from the outside and lock it in position from the inside with the cap nut.



Press from the inside



Press from the outside



Push opening out



Grommet from the outside



Cap nut inside

Proceed as follows to feed a cable through the cable grommet:

- Unscrew the nut of the cable gland until it is positioned on the very end of the thread. Alternatively, you can remove it completely.
- Remove the plug, leaving the seal in the screw fitting.
- Feed the cable through the nut and the cable gland into the clamping cavity. Make sure there is an adequate length of cable on the inside of the housing cover.
- Connect the cable as shown in the connection diagram.
- Tighten the nut (without exerting excessive force) to achieve reliable sealing.

17 Service

17.1 Connections on the Controller Housing

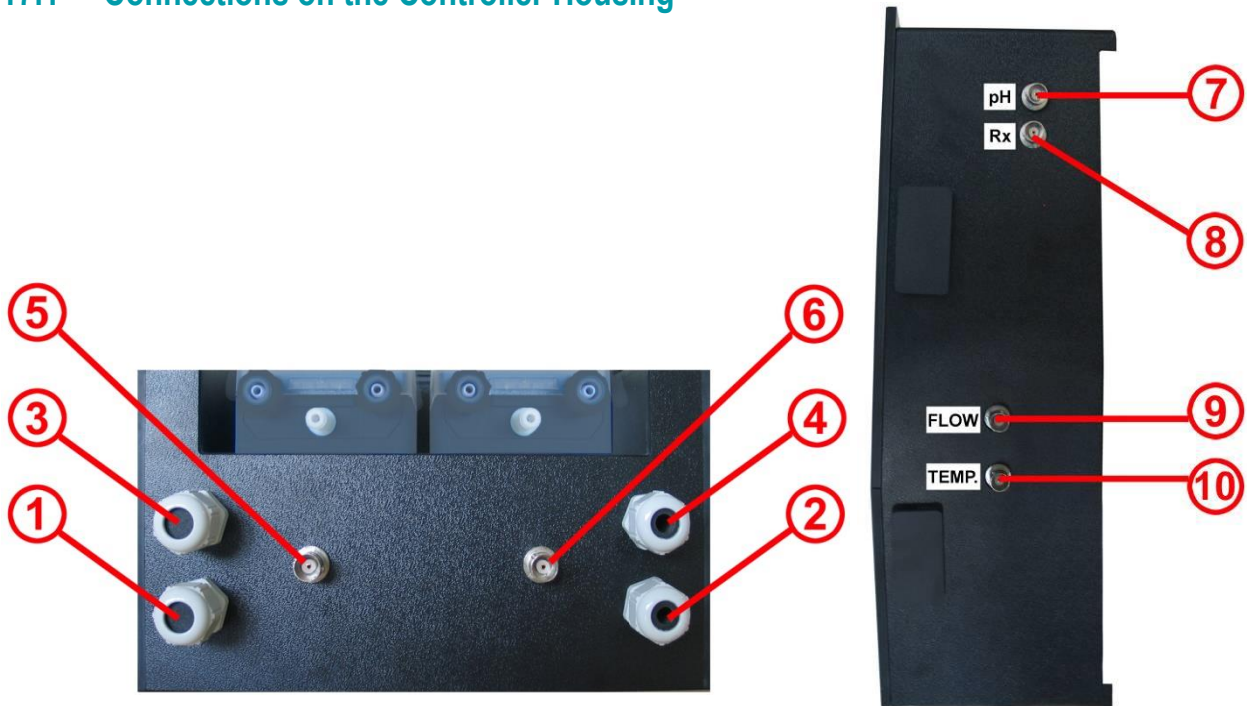

Figure: Controller housing from below Figure: Controller housing from the right

Controller housing - bottom	
1	Power plug, power supply (240V, 50Hz) for controller – continuous power supply
2	Power plug, power supply (240V, 50Hz) for dosing pump – connect via circulating pump (Circulation on => Power supply for dosing pumps present; Circulation off => Power supply for dosing pumps not present)
3	Flockmatic® connection (optional in all care variants)
4	Magnetic valve connection (only for Pool Relax Bromine)
5	Connection for level switch of pH suction lance
6	Connection for level switch of suction lance for Chloriliquide / Bayrosoft® (for Pool Relax Bromine: BNC connector)
Controller housing - right side	
7	pH electrode connection
8	Redox electrode connection
9	Flow switch connection
10	Temperature sensor connection (Pool Relax O ₂ only, otherwise BNC connector)

For safety reasons, Pool Relax features separate supply voltages for the pH and Chloriliquide / Bayrosoft® dosing pumps as described above.

If the supply voltage for the dosing pumps is to be provided via a continuous power source and not via the circulation, the power plug of connection 2 can be connected to the same supply as the controller.



ATTENTION

Connecting the power supply of the dosing pumps with a continuous power source bypasses an important safety feature. Use of the locking system via the circulation is strongly recommended.

17.2 Connections in the Controller Housing

The following figure shows the controller board with all connecting terminals.

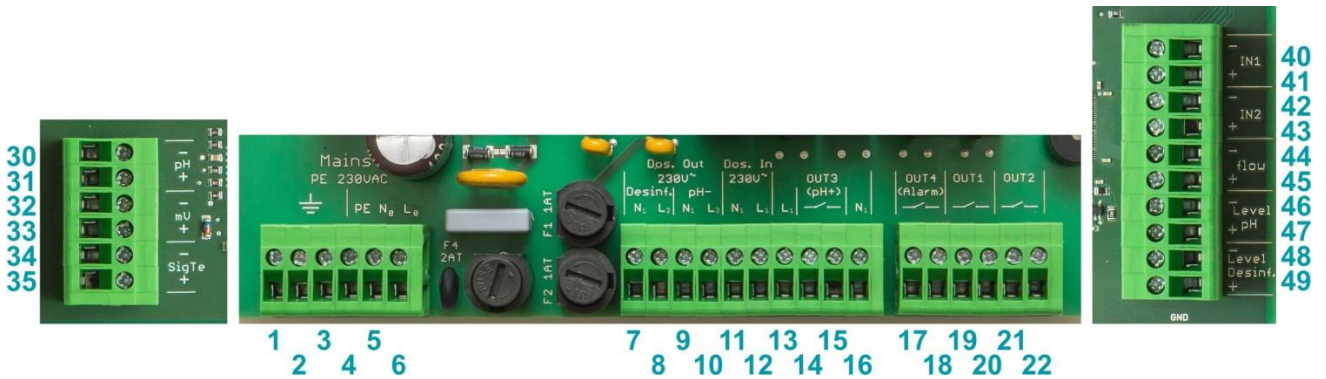

Group	Function	Individual connections	
1, 2, 3	PE (protective earth) for dosing pumps or other connected 230 V~ devices	1	PE
		2	PE
		3	PE
4, 5, 6	230 V AC connection for power supply of Pool Relax. This input is independent of the supply of the dosing outputs (7/8 or 9/10).	4	PE
		5	N (device input)
7, 8	Dosing output, disinfection This output is internally protected with 1 A slow.	7	N (disinf. output)
		8	L (disinf. output)
9, 10	Dosing output pH- This output is internally protected with 1 A slow.	9	N (pH- output)
		10	L (pH- output)
11, 12	Input for the power supply of the dosing outputs disinfection [terminals 7 / 8] und pH- [terminals 9 / 10].	11	N (pH/disinf. input)
		12	L (pH/disinf. input)
13	230V~ L1 can be bridged to OUT3 (pH+) [terminal 14], to uses OUT3 (pH+) as a 230V~ output.	13	L1
14, 15	Output OUT3 (pH+) - volts-free - Max. 4 A - Internal fuse 4 A slow	14	Relay OUT3 (pH+)
		15	Relay OUT3 (pH+)
16	230 V~ N connection for a device controlled by the OUT3 (pH+) output.	16	N ₁
17, 18	Output OUT4 (Alarm) - volts-free - Max. 4 A - NO internal fuse	17	Relay OUT4 (Alarm)
		18	Relay OUT4 (Alarm)
19, 20	Output OUT1 - volts-free - Max. 4 A - NO internal fuse	19	Relay OUT1
		20	Relay OUT1
21, 22	Output OUT2 - volts-free - Max. 4 A - NO internal fuse	21	Relay OUT2
		22	Relay OUT2
30, 31	pH signal (from pH electrode)	30	+
		31	-
32, 33	mV signal (from redox electrode)	32	+
		33	-

Group	Function	Individual connections	
34, 35	Temperature signal Temperature sensor PT1000 (alternative KTY83)	34	+
		35	-
40, 41	Input IN1 - To connect external volts-free contacts for add-on functions (e.g. level monitoring Flockmatic®)	40	Ext. contact (GND)
		41	Ext. contact
42, 43	Input IN2 - To connect external volts-free contacts for add-on functions (e.g. level monitoring Flockmatic®)	42	Ext. contact (GND)
		43	Ext. contact
44, 45	Flow - Input to connect the flow switch (volts-free)	44	Ext. contact (GND)
		45	Ext. contact
46, 47	Level input pH - Input to connect the pH level switch (volts-free)	46	Ext. contact (GND)
		47	Ext. contact
48, 49	Level input disinfection - Input to connect the disinfection level switch (volts-free) (chlorine or Bayrosoft®, volts-free)	48	Ext. contact (GND)
		49	Ext. contact

17.3 Opening the housing

This must only be done by a trained and experienced specialist!

- Disconnect the power-supply to the controller and to the dosing pumps. Make sure the controller and dosing pumps remain without power supply!
- Disconnect all plug connection (sensors, flow switch, level switch of the suction lances and so on).
- Disconnect the dosing hoses on the dosing pumps.



DANGER

Make sure the 2 liquids in the hoses cannot get in touch!

Make sure the 2 hoses of the liquids cannot get in touch!

There is danger of hazardous chemical reaction. Risk of health and life!



1



2



3

1. Open the pump cover by pulling it down
2. Open the fixing screw of the controller, take off the housing and place it upside down on a clean and soft surface.
3. Remove the eight screws on the back lid of the controller. Take off the back lid.

- To close and mount the controller housing proceed In reverse order. Make sure all connections and screw connections are safe and tight.

17.4 Controller Board

The following figure shows the relevant component positions on the controller board.

1. Terminal block for 230 V~ supply of the controller
2. Terminal block for 230 V~ relay outputs
3. Terminal block for sensors
4. Terminal block for switch inputs
5. USB connector for USB memory stick (for software update)
6. Buffer battery for the internal clock (type CR2032)
7. Connector for future plug-in extensions
8. Fuse 2A T for controller supply (20 mm, slow)
9. Fuse 1A T for dosing pH- (20 mm, slow)
10. Fuse 1A T for dosing disinfection (20 mm, slow)
11. Fuse 4A T for output OUT3 (pH+) (20 mm, slow)
12. Relay OUT3 (pH+), max. 4 A
13. Relay OUT4 (Alarm), max. 4 A
14. Relay OUT1, max. 4 A
15. Relay OUT2, max. 4 A
16. Electronic Relay for dosing disinfection
17. Electronic Relay for dosing pH-
18. Display and touch connector
19. Buzzer for touch sound
20. Buzzer for alarm sound

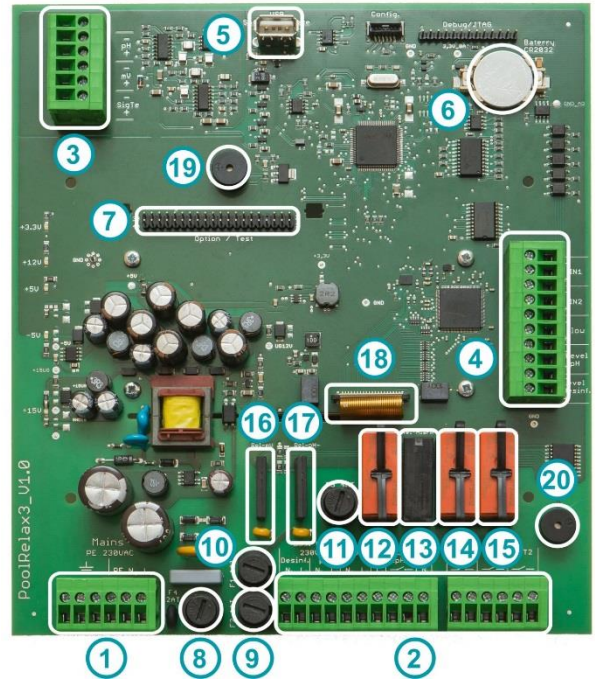

Figure: Controller board

17.4.1 Changing the Buffer Battery

The buffer battery (CR 2032) is retained in a special holder and is easy to replace. The plus pole on the battery faces upwards. The position of the battery can be seen in the picture.

17.4.2 Changing the Fuse

Each of the 230 VAC supplies of the dosing outputs for pH and disinfection (mV or O₂) and the power supply of the controller is protected by a 1A T (20 mm, slow) fuse. The fuses are mounted in a special fuse holder and are easy to replace. The fuse holder is opened using a flat screwdriver.

The position of the fuse holders is shown in the picture.

18 Changing the care method

The maintenance program (oxygen (O₂ / Bayrosoft®) / Chlorine (Cl) / Bromine (Br)) is changed in the menu *Main Menu (Service) → Service Functions → Config. Care Program*

The new program that is desired and a matching code number has to be entered. The code number depends on the current care method **and** on the new care method selected:

Current program	New program	Code number
Pool Relax O ₂	Pool Relax Cl	122
Pool Relax O ₂	Pool Relax Br	123
Pool Relax Cl	Pool Relax O ₂	221
Pool Relax Cl	Pool Relax Br	223
Pool Relax Br	Pool Relax O ₂	321
Pool Relax Br	Pool Relax Cl	322

19 Software update

19.1 Preparation of the USB memory stick

- Copy the two software update files PR3-APPxxxxxxx.BIC (application update) and PR3-LDxxxxxxx.BIC (Bootloader update) to the root directory of a standard USB memory stick.
- In case there are older software update files on the USB memory stick delete them before copying the new ones.

19.2 Opening the housing and mounting a USB memory stick

- Please follow the instructions in chapter 17.3 to open the housing and plug-in a USB memory stick.

19.3 Bootloader Update

- Menu > Main Menu (Service) | Service Code No. 5678 > Service Functions > Software Update > BOOTLOADER Update
- If „BOOTLOADER Update“ does not appear in the menu (but „no entry“ appears instead), the USB memory stick could not be detected or the files on the USB memory stick are missing, wrong or corrupt.
- The installed Bootloader version on the system is displayed as well as the new Bootloader version on the USB memory stick.
- Press the button „Start BOOTLOADER Update“
- Wait for the Bootloader Update to complete (Message „Congratulations...“)
- Press the „OK“ button
- The controller automatically performs a restart

19.4 PR3 Software Update (Application software)

- Menu > Main Menu (Service) | Service Code No. 5678 > Service Functions > Software Update > PR3 Software Update
- If „PR3 Software Update“ does not appear in the menu (but „no entry“ appears instead), the USB memory stick could not be detected or the files on the USB memory stick are missing, wrong or corrupt.
- The installed PR3 Software version on the system is displayed as well as the new PR3 Software version on the USB memory stick.
- Press the button „Start Software Update“
- The controller automatically performs a restart and starts the Bootloader in order to do the software update.
- The Bootloader displays once more the installed PR3 Software version on the system as well as the new PR3 Software version on the USB memory stick.
- Press the „OK“ button to start the PR3 Software update.
- Wait for the PR3 Software Update to complete (Message „Congratulations...“)
- Press the „OK“ button
- The controller automatically performs a restart

19.5 Check of the Installed Software Version

- Home > Help

20 Troubleshooting and fault elimination

The following table lists typical problems that may occur when operating Pool Relax. Each of these problems is accompanied by a description of its possible causes and measures to correct the fault.

The table is subdivided into the pH, mV (redox), O2 and temperature modules.

Type of problem	Possible causes	Elimination of problem
pH measurement		
pH control measurement and device display differ	Calibration is faulty or has not been performed for an excessively long time	Recalibrate the system
Calibration fault during the pH calibration	Faulty input of calibration values	Repeat the calibration
	Electrode is dirty or faulty	Clean the electrode in 5-10 % hydrochloric acid and rinse with distilled water. If it is not possible to calibrate the electrode after this treatment, it must be replaced.
	Humidity in the cable combination	Dry or replace the cable combination
	Measuring amplifier is faulty	Device must be repaired or replaced
pH control / pH dosing		
A dosing rate of 0 % is displayed on the device although there is a deviation between the actual value and the setpoint	Dosing is blocked by an alarm (flow, level or dosing time alarm)	Remove cause of alarm, quit alarm
	Power-on delay still running	Wait for the power-on delay to end
Dosing pump is not working although the dosing rate displayed on the device is not equal to 0 %	Dosing pump fuse is blown	Replace the fuse (1 A slow)
	Dosing relay is faulty	Replace the faulty relay
	Dosing pump is faulty	Replace the dosing pump
Dosing pump is working but there is no pH correction	Container is empty	Replenish the pool care product
	Dosing pump drew air and is no longer dosing	Purge the air from the dosing head
pH value is fluctuating around the setpoint	Dosing rate of the pH control is too high	Set the p-range to a higher value to reduce the dosing rate. A reduction in the minimum switch-on time prevents overdosing as well.
pH value differs from the setpoint over an extended period	Dosing rate of the pH control is too low	Set the p-range to a lower value to increase the dosing rate. As well, an increase in the minimum switch-on time results in a more rapid approach of the setpoint.
Redox measurement		
Redox potential is not equal to the control measurement	Calibration is faulty or has not been performed for an excessively long time	Recalibrate the system
Calibration fault during redox calibration	Faulty input of calibration values	Repeat the calibration
	Electrode is dirty or faulty	Clean the electrode in 5-10 % hydrochloric acid and rinse with distilled water. If it is not possible to calibrate the electrode after this treatment, it must be replaced.
	Humidity in the cable combination	Dry or replace the cable combination
	Measuring amplifier is faulty	Device must be repaired or replaced

Type of problem	Possible causes	Elimination of problem
Redox control (chlorine or bromine dosing)		
A dosing rate of 0 % is displayed on the device although there is a deviation between the actual value and the setpoint	Dosing is blocked by an alarm (flow, level or dosing time alarm)	Remove cause of alarm, quit alarm
	Power-on delay still running	Wait for the power-on delay to end
Dosing pump is not working although the dosing rate displayed on the device is not equal to 0 %	Dosing pump fuse is blown	Replace the fuse (1A slow)
	Dosing relay is faulty	Replace the faulty relay
	Dosing pump is faulty	Replace the dosing pump
Dosing pump is working but there is no redox correction	Container is empty	Replenish the pool care product
	Dosing pump drew air and is no longer dosing	Purge the air from the dosing head
Redox potential is fluctuating around the setpoint	Dosing rate of the redox control is too high	Set the p-range to a higher value to reduce the dosing rate. A reduction in the minimum switch-on time prevents overdosing as well.
Redox potential differs from the setpoint for an extended period	Dosing rate of the redox control is too low	Set the p-range to a lower value to increase the dosing rate. As well, an increase in the minimum switch-on time results in a more rapid approach of the setpoint.
O2 automatic dosing system		
Device does not start dosing at the expected time	Dosing is blocked by an alarm (flow or level alarm)	Remove cause of alarm, quit alarm
	Date and time of the measuring and control devices are set incorrectly	Set the date and time on the customer level
Dose amount is higher than the programmed dose amount	The actual dose amount increases due to the temperature compensation	-
Dosing pump is not working although the device indicates that dosing is in progress	Dosing pump fuse is blown	Replace the fuse (1A slow)
	Dosing relay is faulty	Replace the faulty relay
	Dosing pump is faulty	Replace the dosing pump
Dosing pump is working but care product is not being introduced into the water	Container is empty	Replenish the pool care product
	Dosing pump drew air and is no longer dosing	Purge the air from the dosing head
Temperature measurement		
Temperature display is faulty	Temperature sensor is faulty	Replace the temperature sensor
	Humidity in the cable combination	Dry or replace the cable combination
	Sensor type is set incorrectly (PT1000 / KTY83)	Correct the setting in the "Temperature" menu (in the Service menu only)

21 Technical Data

Measurement dimensions / ranges	
pH	0 – 9,99
Redox	0 – 999 mV
Temperature	0 – 49,9 °C (Standard in Pool Relax Oxygen only)
Measurement amplifier tolerances	
pH / Redox	max. +/- 0.5 % from measurement range terminal value t
Temperature	max. +/- 0.5 °C
Measuring inputs	
pH, redox and temperature via BNC	
Control	
Proportional control pH / redox	
Mono- or bi-directional control for pH, uni-directional control for redox	
Dosing outputs	
Up to 3 relay switch outputs 230 V~ (max. 2 A) for dosing pumps.	
Pulse width control.	
Capacity of dosing pumps	
pH / Chloriliquide:	1,5 l/h
Bayrosoft®:	3,0 l/h
Max. counter pressure of dosing pumps	
max. 1,3 bar	
Suction height	
max. 3 m	
Monitoring and alarm functions	
Measurement readings, adjustable lower and upper alarm limits	
Dosing time alarm	
Water flow through the measuring cell	
Level pH (canister fill level pH)	
Level Disinfection (canister fill level Chloriliquide / Bayrosoft®)	
Alarm relay	
Volts-free (max. 4 A, 230 V~)	
Inputs / outputs for add-on functions	
4 relay switch outputs (volts-free, max. 4 A, 230 V~)	
(2 of these can alternatively be used as alarm relay or pH-Plus dosing relay)	
2 universal switch inputs (connect volts-free contacts only!)	
Optional Extensions	
1 connector for optional extensions (Embedded web server, from 2018)	
Communication	
Optional plug-in module: Embedded web server (future option from 2018)	
Electrical connection	
100 – 240 V~, 50/60 Hz	
Temperature ranges	
Operating temperature	0 °C – 50 °C
Storage temperature	-20 °C – 70 °C
Controller protection class	
IP 54	
Overall dimensions	
440 x 351 x 125 mm (H x W x D)	

22 EC Declaration of Conformity

EC Declaration of Conformity

We,

**BAYROL Deutschland GmbH
Robert-Koch-Str. 4
82152 Planegg/Steinkirchen
Germany**

, hereby declare that the models of the product named in the following that we bring into circulation meet the requirements of the indicated EC directive.

This declaration will lose its validity in the event of uncoordinated modifications to the product.

Product designation: **Measurement, control, and dosing system
Pool Relax 3 (from 2017)**

Product model: **Pool Relax 3 (from 2017)**

Series no.: **See type plate**

EC directives: **EC - Low Voltage Directive (2014/35/EU)
EC - EMC Directive (2014/30/EU)**

Harmonizing standards used: **EN61000-3-2
EN61000-3-3
EN61000-4-2
EN61000-4-3
EN61000-4-3
EN61000-4-4
EN61000-4-5
EN61000-4-6
EN61000-4-8
EN61000-4-11**

Date, manufacturer signature: **02.01.2017,**

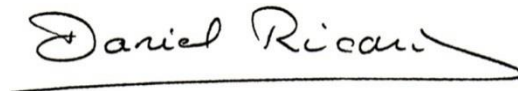

Signer's information: **Managing Director BAYROL Group**